

*Pioneer*

AV Receiver

**VSX-522-K**

Operating Instructions

## IMPORTANT



The lightning flash with arrowhead symbol, within an equilateral triangle, is intended to alert the user to the presence of uninsulated "dangerous voltage" within the product's enclosure that may be of sufficient magnitude to constitute a risk of electric shock to persons.



**CAUTION:**  
TO PREVENT THE RISK OF ELECTRIC SHOCK, DO NOT REMOVE COVER (OR BACK). NO USER-SERVICEABLE PARTS INSIDE. REFER SERVICING TO QUALIFIED SERVICE PERSONNEL.



The exclamation point within an equilateral triangle is intended to alert the user to the presence of important operating and maintenance (servicing) instructions in the literature accompanying the appliance.

D3-4-2-1-1\_A1\_En

## WARNING

This equipment is not waterproof. To prevent a fire or shock hazard, do not place any container filled with liquid near this equipment (such as a vase or flower pot) or expose it to dripping, splashing, rain or moisture.

D3-4-2-1-3\_A1\_En

## WARNING

*Before plugging in for the first time, read the following section carefully.*

**The voltage of the available power supply differs according to country or region. Be sure that the power supply voltage of the area where this unit will be used meets the required voltage (e.g., 230 V or 120 V) written on the rear panel.**

D3-4-2-1-4\*\_A1\_En

## VENTILATION CAUTION

When installing this unit, make sure to leave space around the unit for ventilation to improve heat radiation (at least 40 cm at top, 20 cm at rear, and 20 cm at each side).

## WARNING

Slots and openings in the cabinet are provided for ventilation to ensure reliable operation of the product, and to protect it from overheating. To prevent fire hazard, the openings should never be blocked or covered with items (such as newspapers, table-cloths, curtains) or by operating the equipment on thick carpet or a bed.

D3-4-2-1-7b\*\_A1\_En

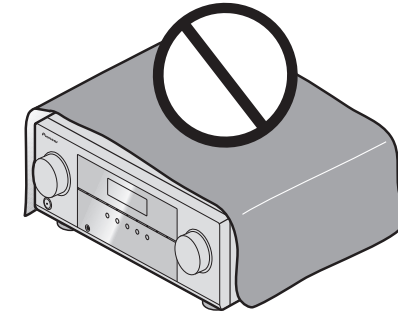

## WARNING

To prevent a fire hazard, do not place any naked flame sources (such as a lighted candle) on the equipment.

D3-4-2-1-7a\_A1\_En

## Operating Environment

Operating environment temperature and humidity:  
+5 °C to +35 °C (+41 °F to +95 °F); less than 85 %RH  
(cooling vents not blocked)

Do not install this unit in a poorly ventilated area, or in locations exposed to high humidity or direct sunlight (or strong artificial light)

D3-4-2-1-7c\*\_A1\_En

This product is for general household purposes. Any failure due to use for other than household purposes (such as long-term use for business purposes in a restaurant or use in a car or ship) and which requires repair will be charged for even during the warranty period.

K041\_A1\_En

(Symbol examples for batteries)

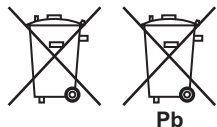

These symbols are only valid in the European Union.

K058c\_A1\_En

If the AC plug of this unit does not match the AC outlet you want to use, the plug must be removed and appropriate one fitted. Replacement and mounting of an AC plug on the power supply cord of this unit should be performed only by qualified service personnel. If connected to an AC outlet, the cut-off plug can cause severe electrical shock. Make sure it is properly disposed of after removal. The equipment should be disconnected by removing the mains plug from the wall socket when left unused for a long period of time (for example, when on vacation).

D3-4-2-2-1a\_A1\_En

## CAUTION

The **STANDBY/ON** switch on this unit will not completely shut off all power from the AC outlet. Since the power cord serves as the main disconnect device for the unit, you will need to unplug it from the AC outlet to shut down all power. Therefore, make sure the unit has been installed so that the power cord can be easily unplugged from the AC outlet in case of an accident. To avoid fire hazard, the power cord should also be unplugged from the AC outlet when left unused for a long period of time (for example, when on vacation).

D3-4-2-2-2a\*\_A1\_En

## Voltage selector

You can find the voltage selector switch on the rear panel of multi-voltage models.

**The factory setting for the voltage selector is 220-240 V. Please set it to the correct voltage for your country or region.**

- Saudi Arabia operates on 127 V and 220 V mains voltage. Please set to the correct voltage before using.
- For Taiwan, please set to 110-127 V before using.
- For Mexico, please set to 110-127 V before using.

Before changing the voltage, disconnect the AC power cord. Use a medium size screwdriver to change the voltage selector switch.

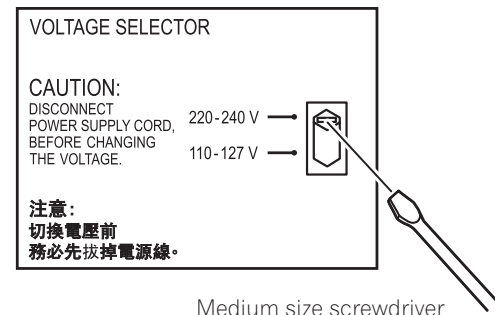

Medium size screwdriver

D3-4-2-1-5\*\_A1\_En

## For Taiwan exclusively

Taiwanese two pin flat-bladed plug

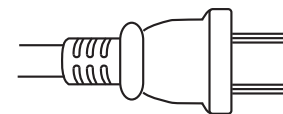

K056\_A1\_En

# Contents

Thank you for buying this Pioneer product. Please read through these operating instructions so you will know how to operate your model properly.

## Before you start . . . . . 5

- Checking what's in the box. . . . . 5
- Installing the receiver . . . . . 5

## Flow of settings on the receiver . . . . . 5

### 01 Controls and displays

- Front panel . . . . . 6
  - Display . . . . . 7
- Remote control. . . . . 8
  - Loading the batteries. . . . . 9
  - Operating range of remote control . . . . . 9

### 02 Connecting your equipment

- Placing the speakers . . . . . 10
  - Hints on the speaker placement . . . . . 10
- Connecting the speakers . . . . . 11
  - Connect the surround back or front height speakers. . . . . 11
- Making cable connections . . . . . 12
  - HDMI cables . . . . . 12
    - About HDMI . . . . . 12
  - Analog audio cables . . . . . 13
  - Digital audio cables. . . . . 13
  - Standard RCA video cables . . . . . 13
- About video outputs connection. . . . . 13
- Connecting a TV and playback components. . . . . 14
  - Connecting using HDMI . . . . . 14
  - Connecting your component with no HDMI terminal . . . . . 15
- Connecting antennas. . . . . 16
  - Using external antennas . . . . . 16
- Connecting an iPod . . . . . 16
- Connecting a USB device. . . . . 17
- Plugging in the receiver . . . . . 17

### 03 Basic Setup

- Before setting up . . . . . 18
  - Changing the TV format setting. . . . . 18
- Canceling the demo display . . . . . 18
- Automatically setting up for surround sound (MCACC) . . . . . 18
  - Other problems when using the Auto MCACC setup. . . . . 19

### 04 Basic playback

- Playing a source . . . . . 20
  - Selecting the audio input signal . . . . . 20
- Playing an iPod. . . . . 22
  - Playing back files stored on an iPod . . . . . 22
  - Basic playback controls. . . . . 22
  - Switches between the iPod controls and the receiver controls . . . . . 22
- Playing a USB device . . . . . 23
  - Basic playback controls. . . . . 23
  - Compressed audio compatibility . . . . . 23
- Listening to the radio . . . . . 24
  - Improving FM sound . . . . . 24
  - Saving station presets . . . . . 24
  - Listening to station presets . . . . . 24
  - Naming preset stations . . . . . 24
  - Changing the radio frequency step . . . . . 24

### 05 Listening to your system

- Choosing the listening mode . . . . . 25
  - Auto playback . . . . . 25
  - Listening in surround sound . . . . . 25
  - Using the Advanced surround . . . . . 26
  - Using Stream Direct . . . . . 26
- Using the Sound Retriever . . . . . 26
- Listening with Acoustic Calibration EQ. . . . . 26
- Better sound using Phase Control . . . . . 27
- Using surround back channel processing . . . . . 27
- Setting the Up Mix function . . . . . 27
- Setting the Audio options . . . . . 28

### 06 Home Menu

- Using the Home Menu . . . . . 30
- Manual speaker setup . . . . . 30
  - Speaker Setting . . . . . 30
  - X.Over . . . . . 31
  - Channel Level . . . . . 31
  - Speaker Distance . . . . . 32
- The Input Assign menu. . . . . 32
- The Pre Out Setting . . . . . 33
- The Auto Power Down menu . . . . . 33
- The FL Demo Mode menu. . . . . 33
- The HDMI Setup menu . . . . . 33

### 07 Additional information

- Troubleshooting . . . . . 35
  - General . . . . . 35
  - HDMI. . . . . 36
  - Important information regarding the HDMI connection. . . . . 36
  - iPod messages . . . . . 36
  - USB messages . . . . . 36
- About iPod/iPhone . . . . . 37
- Resetting the main unit. . . . . 37
- Cleaning the unit . . . . . 37
- Specifications . . . . . 38

## Before you start

### Checking what's in the box

Please check that you've received the following supplied accessories:

- Setup microphone
- Remote control
- AAA size IEC R03 dry cell batteries (to confirm system operation) x2
- AM loop antenna
- FM wire antenna
- Power cord
- Quick start guide
- Safety Brochure
- These operating instructions (CD-ROM)

### Installing the receiver

- When installing this unit, make sure to put it on a level and stable surface.

Don't install it on the following places:

- on a color TV (the screen may distort)
- near a cassette deck (or close to a device that gives off a magnetic field). This may interfere with the sound.
- in direct sunlight
- in damp or wet areas
- in extremely hot or cold areas
- in places where there is vibration or other movement
- in places that are very dusty
- in places that have hot fumes or oils (such as a kitchen)

## Flow of settings on the receiver

The unit is a full-fledged AV receiver equipped with an abundance of functions and terminals. It can be used easily after following the procedure below to make the connections and settings.

The colors of the steps indicate the following:

### Required setting item

### Setting to be made as necessary

#### 1 Connecting the speakers

Where you place the speakers will have a big effect on the sound.

- Placing the speakers ([page 10](#))
- Connecting the speakers ([page 11](#))

#### 2 Connecting the components

For surround sound, you'll want to hook up using a digital connection from the Blu-ray Disc/DVD player to the receiver.

- About video outputs connection ([page 13](#))
- Connecting a TV and playback components ([page 14](#))
- Connecting antennas ([page 16](#))
- Plugging in the receiver ([page 17](#))

#### 3 Power On

Make sure you've set the video input on your TV to this receiver. Check the manual that came with the TV if you don't know how to do this.

#### 4 Making the initial settings according to the region and environment in which you live

- Changing the TV format setting ([page 18](#))
- Changing the radio frequency step ([page 24](#))

#### 5 The Pre Out Setting ([page 33](#))

(When connecting the front height speakers.)

#### The Input Assign menu ([page 32](#))

(When using connections other than the recommended connections.)

#### The HDMI Setup menu ([page 33](#))

(When the connected TV supports the HDMI Audio Return Channel function.)

#### 6 Use the on-screen automatic MCACC setup to set up your system

- Automatically setting up for surround sound (MCACC) ([page 18](#))

#### 7 Basic playback ([page 20](#))

- Selecting the audio input signal ([page 20](#))
- Playing an iPod ([page 22](#))
- Playing a USB device ([page 23](#))
- Choosing the listening mode ([page 25](#))

#### 8 Adjusting the sound as desired

- Using the Sound Retriever ([page 26](#))
- Better sound using Phase Control ([page 27](#))
- Listening with Acoustic Calibration EQ ([page 26](#))
- Using surround back channel processing ([page 27](#))
- Setting the Up Mix function ([page 27](#))
- Setting the Audio options ([page 28](#))
- Manual speaker setup ([page 30](#))

## Front panel

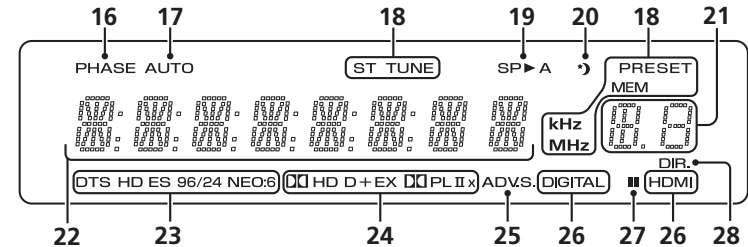
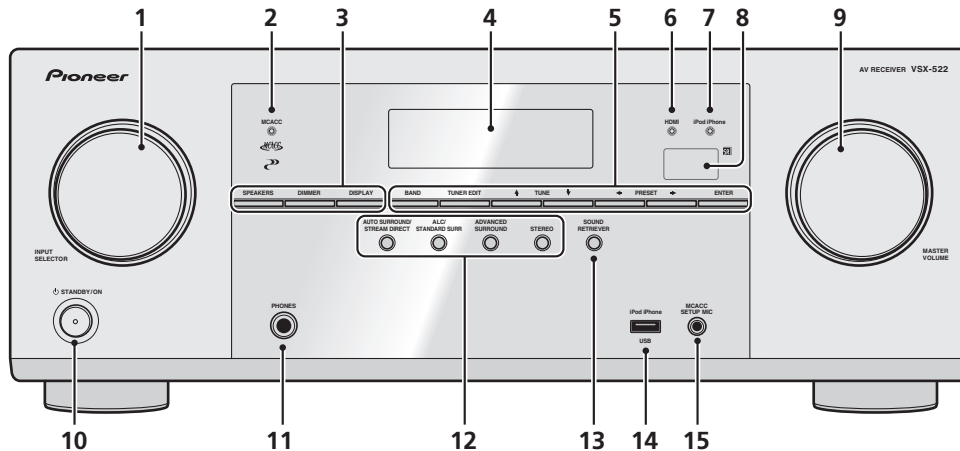
**1 INPUT SELECTOR dial**

Selects an input source ([page 20](#)).

**2 MCACC indicator**

Lights when Acoustic Calibration EQ ([page 26](#)) is on (Acoustic Calibration EQ is automatically set to on after the Auto MCACC setup ([page 18](#))).

**3 Receiver control buttons**

**SPEAKERS** – Use to change the speaker system on or off. When the **SP OFF** is selected, no sound is output from the speakers connected to this receiver.

**DIMMER** – Dims or brightens the display. The brightness can be controlled in four steps.

**DISPLAY** – Switches the display of this unit. The listening mode, sound volume, Pre Out setting or input name can be checked by selecting an input source.

- The Pre Out setting may or may not be displayed, depending on the input source you have selected.

**4 Character display**

See [Display on page 7](#).

**5 Tuner control buttons**

**BAND** – Switches between AM, FM ST (stereo) and FM MONO radio bands ([page 24](#)).

**TUNER EDIT** – Use with **TUNE**  $\uparrow/\downarrow$ , **PRESET**  $\leftarrow/\rightarrow$  and **ENTER** to memorize and name stations for recall ([page 24](#)).

**TUNE**  $\uparrow/\downarrow$  – Used to find radio frequencies ([page 24](#)).

**PRESET**  $\leftarrow/\rightarrow$  – Use to select preset radio stations ([page 24](#)).

**6 HDMI indicator**

Blinks when connecting an HDMI-equipped component; lights when the component is connected ([page 14](#)).

**7 iPod/iPhone indicator**

Lights when an iPod/iPhone is connected and **iPod/USB** input is selected ([page 22](#)).

**8 Remote sensor**

Receives the signals from the remote control (see [Operating range of remote control on page 9](#)).

**9 MASTER VOLUME dial****10  $\phi$ STANDBY/ON****11 PHONES jack**

Use to connect headphones. When the headphones are connected, there is no sound output from the speakers. The listening mode when the sound is heard from the headphone can be selected only from **PHONES SURR**, **STEREO** or **STEREO ALC** mode.

**12 Listening mode buttons**

**AUTO SURROUND/STREAM DIRECT** – Switches between Auto surround mode ([page 25](#)) and Stream Direct playback ([page 26](#)).

**ALC/STANDARD SURR** – Press for standard decoding and to switch between the modes of  $\square\square$  Pro Logic II,  $\square\square$  Pro Logic IIx,  $\square\square$  Pro Logic IIz and NEO:6, and the Auto level control stereo mode ([page 25](#)).

**ADVANCED SURROUND** – Switches between the various surround modes ([page 26](#)).

**STEREO** – Press to select stereo playback ([page 25](#)).

**13 SOUND RETRIEVER**

Press to restore CD quality sound to compressed audio sources ([page 26](#)).

**14 iPod iPhone USB terminal**

Use to connect your Apple iPod or USB mass storage device as an audio source ([page 16](#)).

**15 MCACC SETUP MIC jack**

Use to connect a microphone when performing Auto MCACC setup ([page 18](#)).

**Display****16 PHASE**

Lights when the Phase Control is switched on ([page 27](#)).

**17 AUTO**

Lights when the Auto Surround feature is switched on ([page 25](#)).

**18 Tuner indicators**

**ST** – Lights when a stereo FM broadcast is being received in auto stereo mode ([page 24](#)).

**TUNE** – Lights when a normal broadcast channel.

**PRESET** – Shows when a preset radio station is registered or called.

**MEM** – Blinks when a radio station is registered.

**kHz/MHz** – Lights when the character display is showing the currently received AM/FM broadcast frequency.

**19 Speaker indicators**

Shows if the speaker system is on or not ([page 6](#)).

**SP▶A** means the speakers are switched on.

**SP▶** means the speakers are switched off.

**20 Sleep timer indicator**

Lights when the receiver is in sleep mode ([page 8](#)).

**21 PRESET information or input signal indicator**

Shows the preset number of the tuner or the input signal type, etc.

**22 Character display**

Displays various system information.

**23 DTS indicators**

**DTS** – Lights when a source with DTS encoded audio signals is detected.

**HD** – Lights when a source with DTS-EXPRESS or DTS-HD encoded audio signals is detected.

**ES** – Lights to indicate DTS-ES decoding.

**96/24** – Lights when a source with DTS 96/24 encoded audio signals is detected.

**NEO:6** – When one of the NEO:6 modes of the receiver is on, this lights to indicate NEO:6 processing ([page 25](#)).

**24 Dolby Digital indicators**

**DD D** – Lights when a Dolby Digital encoded signal is detected.

**DD D+** – Lights when a source with Dolby Digital Plus encoded audio signals is detected.

**DDHD** – Lights when a source with Dolby TrueHD encoded audio signals is detected.

**EX** – Lights to indicate Dolby Digital EX decoding.

**DDPLII(x)** – Lights to indicate **DD** Pro Logic II/**DD** Pro Logic IIx decoding. Light will go off during **DD** Pro Logic IIz decoding (see [Listening in surround sound on page 25](#) for more on this).

**25 ADV.S.**

Lights when one of the Advanced Surround modes has been selected (see [Using the Advanced surround on page 26](#) for more on this).

**26 SIGNAL SELECT indicators**

**DIGITAL** – Lights when a digital audio signal is selected. Blinks when a digital audio signal is selected and selected audio input is not provided.

**HDMI** – Lights when an HDMI signal is selected. Blinks when an HDMI signal is selected and selected HDMI input is not provided.

**27 Up Mix/DIMMER indicator**

Lights when the Up Mix function is set to **ON** ([page 27](#)). Also, lights when DIMMER is set to off.

**28 DIR.**

Lights when the **DIRECT** or **PURE DIRECT** mode is switched on ([page 26](#)).



## Remote control

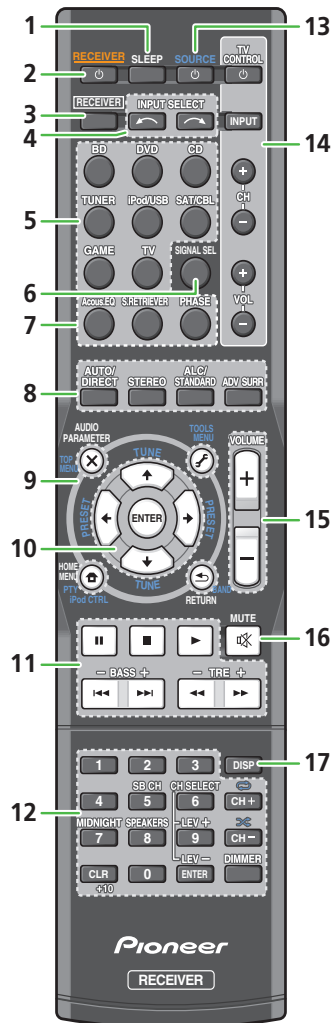

As for operating other devices, the remote control codes for the Pioneer products are preset. The settings cannot be changed.

### 1 SLEEP

Press to change the amount of time before the receiver switches into standby (**30 min – 60 min – 90 min – Off**). You can check the remaining sleep time at any time by pressing **SLEEP** once.

### 2 RECEIVER

Switches the receiver between standby and on.

### 3 RECEIVER

Switches the remote to control the receiver (used to select the white commands above the number buttons (**MIDNIGHT**, etc)). Also use this button to set up surround sound ([page 30](#)) or Audio parameters ([page 28](#)).

### 4 INPUT SELECT

Use to select the input source ([page 20](#)).

### 5 Input function buttons

Use to select the input source to this receiver ([page 20](#)). This will enable you to control other Pioneer components with the remote control.

### 6 SIGNAL SEL

Press to select the audio input signal of the component to play back ([page 20](#)).

### 7 Sound control buttons

**Acous.EQ** – Press to switch on/off Acoustic Calibration EQ setting ([page 26](#)).



**S.RETRIEVER** – Press to restore CD quality sound to compressed audio sources ([page 26](#)).

**PHASE** – Press to switch on/off Phase Control ([page 27](#)).

### 8 Listening mode buttons

**AUTO/DIRECT** – Switches between Auto surround mode ([page 25](#)) and Stream Direct playback ([page 26](#)).

**STEREO** – Press to select stereo playback ([page 25](#)).

**ALC/STANDARD SURR** – Press for standard decoding and to switch between the modes of  Pro Logic II,  Pro Logic IIx,  Pro Logic IIz and NEO:6, and the Auto level control stereo mode ([page 25](#)).

**ADV SURR** – Switches between the various surround modes ([page 26](#)).

### 9 Receiver and component control buttons

The following button controls can be accessed after you have selected the corresponding input function button (**BD**, **DVD**, etc.).

Press **RECEIVER** first to access:

**AUDIO PARAMETER** – Use to access the Audio options ([page 28](#)).

**HOME MENU** – Press to access the Home Menu ([page 30](#)).

**RETURN** – Confirm and exit the current menu screen.

Press **BD** or **DVD** first to access:

**TOP MENU** – Displays the disc 'top' menu of a Blu-ray Disc/DVD.

**HOME MENU** – Displays the HOME MENU screen.

**RETURN** – Confirm and exit the current menu screen.

**MENU** – Displays the TOOLS menu of Blu-ray Disc player.

Press **TUNER** first to access:

**TOOLS** – Memorizes stations for recall ([page 24](#)), also used to change the name ([page 24](#)).





**BAND** – Switches between AM, FM ST (stereo) and FM MONO radio bands ([page 24](#)).

Press **iPod/USB** first to access:

**iPod CTRL** – Switches between the iPod controls and the receiver controls ([page 22](#)).

### 10 (TUNE , PRESET )

Use the arrow buttons when setting up your surround sound system ([page 30](#)). Also used to control Blu-ray Disc/DVD menus/options.

Use **TUNE  ** can be used to find radio frequencies and **PRESET  ** can be used to select preset radio stations ([page 24](#)).



## 11 Component control buttons

The main buttons (▶, ■, etc.) are used to control a component after you have selected it using the input function buttons.

The controls above these buttons can be accessed after you have selected the corresponding input function button (**BD**, **DVD** and **CD**). These buttons also function as described below.

Press **RECEIVER** first to access:

**BASS +/-, TRE +/-** – Use to adjust Bass or Treble.

- These controls are disabled when the listening mode is set to **DIRECT** or **PURE DIRECT**.
- When the front speaker is set at **SMALL** in the Speaker Setting (or automatically via the Auto MCACC setup) and the X.Over is set above 150 Hz, the subwoofer channel level will be adjusted by pressing **BASS +/-** (page 31).

## 12 Number buttons and other component controls

Use the number buttons to directly select a radio frequency (page 24) or the tracks on a CD, etc. There are other buttons that can be accessed after **RECEIVER** is pressed. (For example **MIDNIGHT**, etc.)

**SB CH** – Press to select **ON**, **AUTO** or **OFF** the surround back channel (page 27).

**CH SELECT** – Press repeatedly to select a channel, then use **LEV +/-** to adjust the level (page 31).

**LEV +/-** – Use to adjust the channel level.

**MIDNIGHT** – Switches to Midnight or Loudness listening (page 28).

**SPEAKERS** – Use to change the speaker system on or off. When the **SP OFF** is selected, no sound is output from the speakers connected to this receiver.

**DIMMER** – Dims or brightens the display. The brightness can be controlled in four steps.

## 13 SOURCE

Turns on or off the power of the Pioneer DVD/DVR units when **BD**, **DVD** or **CD** is selected using the input function buttons.

## 14 TV CONTROL buttons

These buttons can control only be used with Pioneer TVs.

⓪ – Use to turn on/off the power of the TV.

**INPUT** – Use to select the TV input signal.

**CH +/-** – Use to select channels.

**VOL +/-** – Use to adjust the volume on your TV.

## 15 VOLUME +/-

Use to set the listening volume.

## 16 MUTE

Mutes/unmutes the sound.

## 17 DISP

Switches the display of this unit. The listening mode, sound volume, Pre Out setting or input name can be checked by selecting an input source.

- The Pre Out setting may or may not be displayed, depending on the input source you have selected.

## Loading the batteries

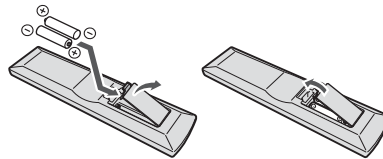

The batteries included with the unit are to check initial operations; they may not last over a long period. We recommend using alkaline batteries that have a longer life.

### ⚠ CAUTION

- Incorrect use of batteries may result in such hazards as leakage and bursting. Observe the following precautions:
  - Never use new and old batteries together.
  - Insert the plus and minus sides of the batteries properly according to the marks in the battery case.
  - Batteries with the same shape may have different voltages. Do not use different batteries together.
  - When disposing of used batteries, please comply with governmental regulations or environmental public institution's rules that apply in your country or area.
  - Do not use or store batteries in direct sunlight or other excessively hot place, such as inside a car or near a heater. This can cause batteries to leak, overheat, explode or catch fire. It can also reduce the life or performance of batteries.

## Operating range of remote control

The remote control may not work properly if:

- There are obstacles between the remote control and the receiver's remote sensor.
- Direct sunlight or fluorescent light is shining onto the remote sensor.
- The receiver is located near a device that is emitting infrared rays.
- The receiver is operated simultaneously with another infrared remote control unit.

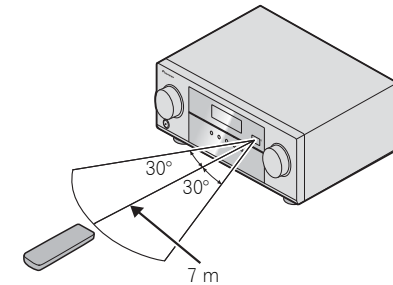

## Placing the speakers

By connecting the left and right front speakers (**L/R**), the center speaker (**C**), the left and right surround speakers (**SL/SR**), and the subwoofer (**SW**), a 5.1 ch surround system can be enjoyed. Further, by using an external amplifier, you can connect the left and right surround back speakers (**SBL/SBR**) or the left and right front height speaker (**FHL/FHR**) to boost your system up to a 7.1 ch surround system.

• You can also connect one surround back speaker (**SB**) and enjoy a 6.1 ch surround system. To achieve the best possible surround sound, install your speakers as shown below.

5.1 channel surround system:

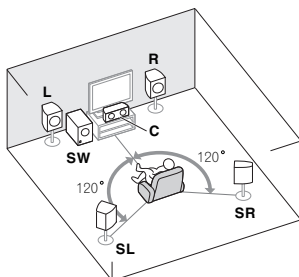

6.1 channel surround (Surround back) system: <sup>a</sup>

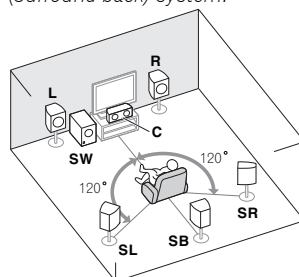

7.1 channel surround (Surround back) system: <sup>a</sup>

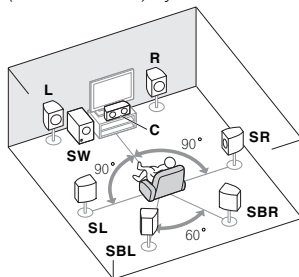

7.1 channel surround (Front height) system: <sup>a</sup>

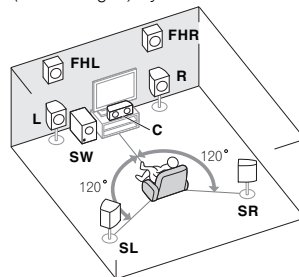

a. This layout is available only when the additional amplifier is connected to the unit and the surround back or front height speakers are connected to the amplifier. For details, see [Connect the surround back or front height speakers on page 11](#).

## Hints on the speaker placement

Where you put your speakers in the room has a big effect on the quality of the sound. The following guidelines should help you to get the best sound from your system.

- The subwoofer can be placed on the floor. Ideally, the other speakers should be at about ear-level when you're listening to them. Putting the speakers on the floor (except the subwoofer), or mounting them very high on a wall is not recommended.
- For the best stereo effect, place the front speakers 2 m to 3 m apart, at equal distance from the TV.
- If you're going to place speakers around your CRT TV, use shielded speakers or place the speakers at a sufficient distance from your CRT TV.
- If you're using a center speaker, place the front speakers at a wider angle. If not, place them at a narrower angle.
- Place the center speaker above or below the TV so that the sound of the center channel is localized at the TV screen. Also, make sure the center speaker does not cross the line formed by the leading edge of the front left and right speakers.
- It is best to angle the speakers towards the listening position. The angle depends on the size of the room. Use less of an angle for bigger rooms.
- Surround and surround back speakers should be positioned 60 cm to 90 cm higher than your ears and tilted slight downward. Make sure the speakers don't face each other. For DVD-Audio, the speakers should be more directly behind the listener than for home theater playback.
- If the surround speakers cannot be set directly to the side of the listening position with a 7.1-channel system, the surround effect can be enhanced by turning off the Up Mix function (see [Setting the Up Mix function on page 27](#)).
- Try not to place the surround speakers farther away from the listening position than the front and center speakers. Doing so can weaken the surround sound effect.
- Place the left and right front height speakers at least one meter directly above the left and right front speakers.

### ⚠ CAUTION

- Make sure that all speakers are securely installed. This not only improves sound quality, but also reduces the risk of damage or injury resulting from speakers being knocked over or falling in the event of external shocks such as earthquakes.

### 📌 Important

- To connect the surround back or front height speakers, an additional amplifier is required. Connect the additional amplifier to the **PRE OUT SURR BACK/FRONT HEIGHT** outputs of this unit and connect the surround back or front height speakers to the additional amplifier (see [Connect the surround back or front height speakers on page 11](#)).

## Connecting the speakers

The receiver will work with just two stereo speakers (the front speakers in the diagram) but using at least three speakers is recommended, and a complete setup is best for surround sound.

Make sure you connect the speaker on the right to the right (R) terminal and the speaker on the left to the left (L) terminal. Also make sure the positive and negative (+/-) terminals on the receiver match those on the speakers.

You can use speakers with a nominal impedance between 6  $\Omega$  and 16  $\Omega$ .

Be sure to complete all connections before connecting this unit to the AC power source.

### Bare wire connections

Front speaker terminals:

- 1 Twist exposed wire strands together.
- 2 Loosen terminal and insert exposed wire.
- 3 Tighten terminal.

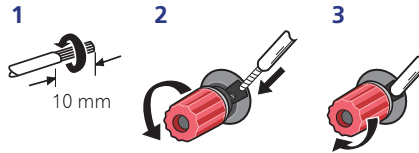

Center and surround speaker terminals:

- 1 Twist exposed wire strands together.
- 2 Push open the tabs and insert exposed wire.
- 3 Release the tabs.

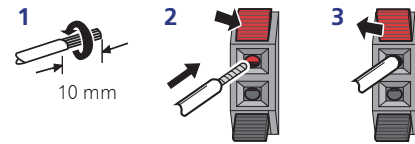

### CAUTION

- These speaker terminals carry **HAZARDOUS LIVE voltage**. To prevent the risk of electric shock when connecting or disconnecting the speaker cables, disconnect the power cord before touching any uninsulated parts.
- Make sure that all the bare speaker wire is twisted together and inserted fully into the speaker terminal. If any of the bare speaker wire touches the back panel it may cause the power to cut off as a safety measure.

### Connect the surround back or front height speakers

Connect the **PRE OUT SURR BACK/FRONT HEIGHT** outputs of the unit and additional amplifier to add a surround back or front height speaker.

- The Pre Out setting must be set if the above connections are performed. Select **Surr.Back** if the surround back speaker is connected and **Height** if the front height speaker is connected (If neither the surround back speaker nor the front height speaker is connected, either setting will suffice) (see [The Pre Out Setting on page 33](#)).
- You can use the additional amplifier on the surround back channel pre-outs for a single speaker as well. In this case plug the amplifier into the left (L (Single)) terminal only.

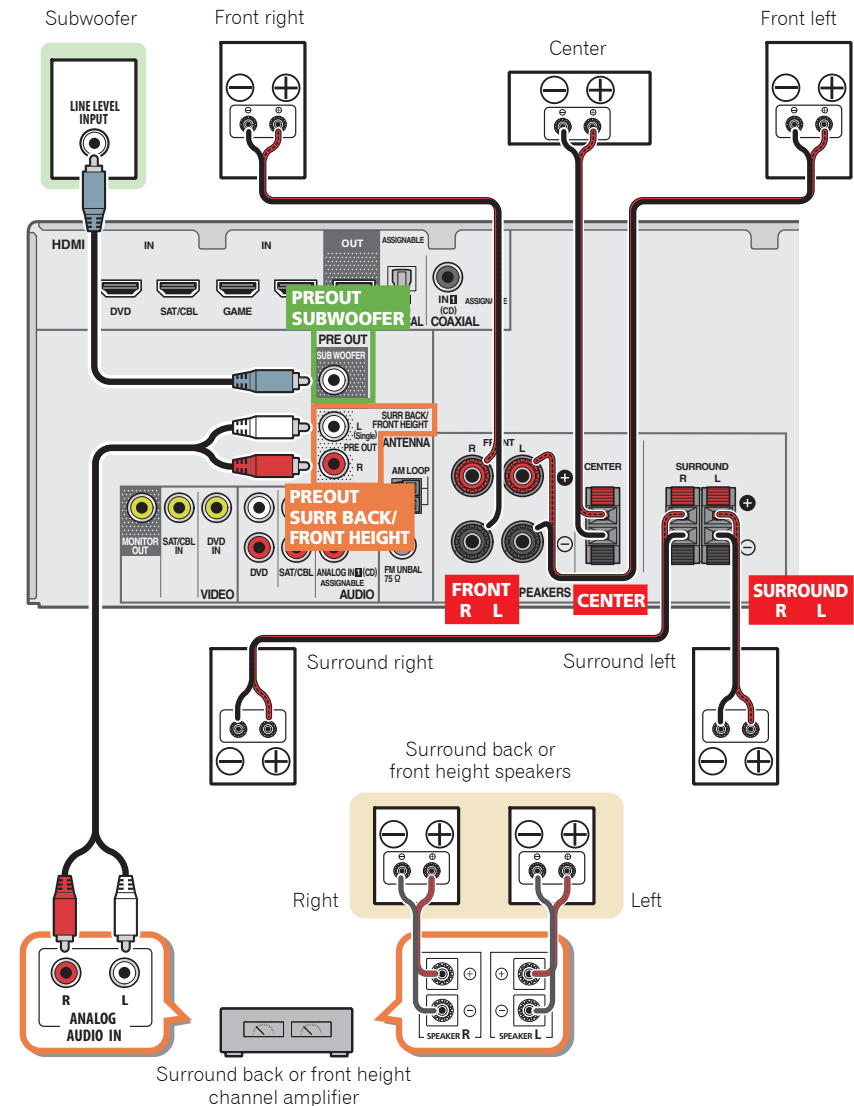

## Making cable connections

Make sure not to bend the cables over the top of this unit (as shown in the illustration). If this happens, the magnetic field produced by the transformers in this unit may cause a humming noise from the speakers.

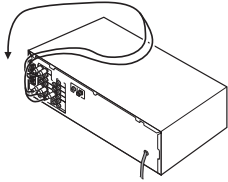

### Important

- Before making or changing connections, switch off the power and disconnect the power cord from the AC outlet.
- Before unplugging the power cord, switch the power into standby.

## HDMI cables

Both video and sound signals can be transmitted simultaneously with one cable. If connecting the player and the TV via this receiver, for both connections, use HDMI cables.

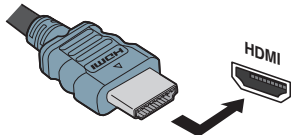

Be careful to connect the terminal in the proper direction.

### Note

- Set the HDMI parameter in [Setting the Audio options on page 28](#) to **THRU** (THROUGH) and set the input signal in [Selecting the audio input signal on page 20](#) to **HDMI**, if you want to hear HDMI audio output from your TV (no sound will be heard from this receiver).

- If the video signal does not appear on your TV, try adjusting the resolution settings on your component or display. Note that some components (such as video game units) have resolutions that may not be displayed. In this case, use a (analog) composite connection.
- When the video signal from the HDMI is 480i, 480p, 576i or 576p, Multi Ch PCM sound and HD sound cannot be received.

## About HDMI

The HDMI connection transfers uncompressed digital video, as well as almost every kind of digital audio that the connected component is compatible with, including DVD-Video, DVD-Audio, SACD, Dolby Digital Plus, Dolby TrueHD, DTS-HD Master Audio (see below for limitations), Video CD/ Super VCD and CD.

This receiver incorporates High-Definition Multimedia Interface (HDMI<sup>®</sup>) technology.

This receiver supports the functions described below through HDMI connections.

- Digital transfer of uncompressed video (contents protected by HDCP (1080p/24, 1080p/60, etc.))
- 3D signal transfer
- Deep Color signal transfer
- x.v.Color signal transfer
- Audio Return Channel (see [The HDMI Setup menu on page 33](#))
- Input of multi-channel linear PCM digital audio signals (192 kHz or less) for up to 8 channels
- Input of the following digital audio formats:
  - Dolby Digital, Dolby Digital Plus, DTS, High bitrate audio (Dolby TrueHD, DTS-HD Master Audio), DVD-Audio, CD, SACD (DSD 2 ch only), Video CD, Super VCD

### Note

- Use a High Speed HDMI<sup>®</sup> cable. If HDMI cable other than a High Speed HDMI<sup>®</sup> cable is used, it may not work properly.
- When an HDMI cable with a built-in equalizer is connected, it may not operate properly.
- 3D, Deep Color, x.v.Color signal transfer and Audio Return Channel are only possible when connected to a compatible component.
- HDMI format digital audio transmissions require a longer time to be recognized. Due to this, interruption in the audio may occur when switching between audio formats or beginning playback.
- Turning on/off the device connected to this unit's HDMI OUT terminal during playback, or disconnecting/ connecting the HDMI cable during playback, may cause noise or interrupted audio.

*The terms HDMI and HDMI High-Definition Multimedia Interface, and the HDMI Logo are trademarks or registered trademarks of HDMI Licensing LLC in the United States and other countries.*

*"x.v.Color" and x.v.Color are trademarks of Sony Corporation.*

### Analog audio cables

Use stereo RCA phono cables to connect analog audio components. These cables are typically red and white, and you should connect the red plugs to R (right) terminals and white plugs to L (left) terminals.

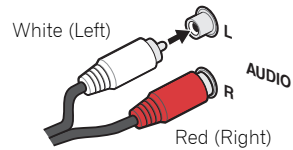

### Standard RCA video cables

These cables are the most common type of video connection and are used to connect to the composite video terminals. The yellow plugs distinguish them from cables for audio.

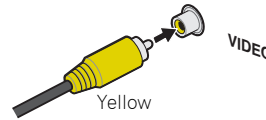

### Digital audio cables

Commercially available coaxial digital audio cables or optical cables should be used to connect digital components to this receiver.

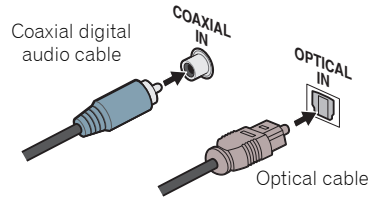

#### Note

- When connecting optical cables, be careful when inserting the plug not to damage the shutter protecting the optical socket.
- When storing optical cable, coil loosely. The cable may be damaged if bent around sharp corners.
- You can also use a standard RCA video cable for coaxial digital connections.

### About video outputs connection

This receiver is not loaded with a video converter. When you use HDMI cables for connecting to the input device, the same cables should be used for connecting to the TV.

The signals input from the analog (composite) video inputs of this unit will not be output from the **HDMI OUT** terminal.

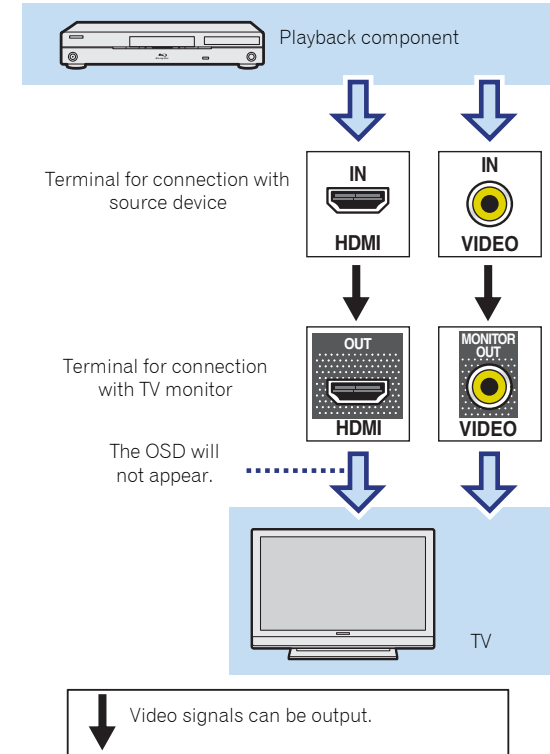

## Connecting a TV and playback components

### Connecting using HDMI

If you have an HDMI or DVI (with HDCP) equipped component (Blu-ray Disc player, etc.), you can connect it to this receiver using a commercially available HDMI cable.

- The following connection/setting is required to listen to the sound of the TV over this receiver.
  - If the TV does not support the HDMI Audio Return Channel function, connect the receiver and TV with audio cables (as shown).
  - If the TV supports the HDMI Audio Return Channel function, the sound of the TV can be input to the receiver via the HDMI terminal, so there is no need to connect an audio cable. In this case, set **ARC** at **HDMI Setup** to **ON** (see [The HDMI Setup menu on page 33](#)).

### Important

- If the receiver is connected to a TV using an HDMI cable, the on-screen display (OSD) will not be displayed. Be sure to use a standard RCA analog video cable to connect. In this case, switch the TV input to analog to see the OSD screen (for setup, etc.) on the TV.
- When the ARC function is **ON** and the receiver is connected to a compatible TV with an HDMI cable, and you switch the input of the TV to composite, the input of the receiver may automatically switch to **TV**. If this happens, switch the receiver's input back to the original input, or turn **OFF** the ARC function (see [The HDMI Setup menu on page 33](#)).

### Note

- In order to listen to the audio from the TV that is connected to this receiver using an analog audio cables, set-up for analog audio input is required (see [The Input Assign menu on page 32](#)).

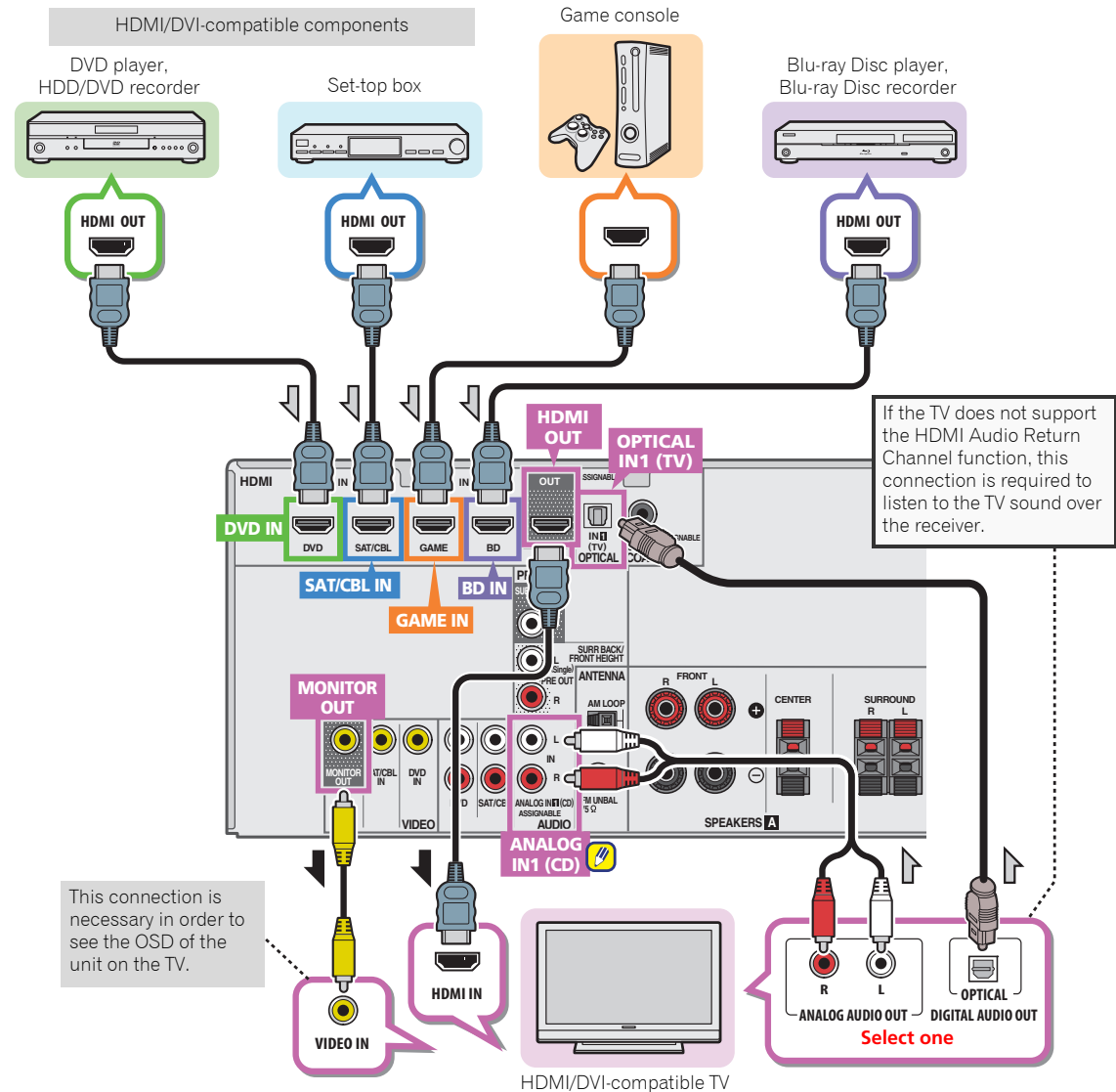

## Connecting your component with no HDMI terminal

This diagram shows connections of a TV and DVD player (or other playback component) with no HDMI terminal to the receiver.

### Note

- In order to listen to the audio from the TV that is connected to this receiver using analog audio cables, set-up for analog audio input is required (see [The Input Assign menu on page 32](#)).
- Only one component can be connected to both the optical input terminal and coaxial input terminal. If connecting other devices, please use a different method to connect the audio.

In order to listen to the audio from the source component that is connected to this receiver using an optical cable or a coaxial cable, first, switch to the **DVD** (DVD player) or **SAT/CBL** (set-top box), then press **SIGNAL SEL** to choose the audio signal **O1** (OPTICAL1) or **C1** (COAXIAL1) (see [Selecting the audio input signal on page 20](#)).

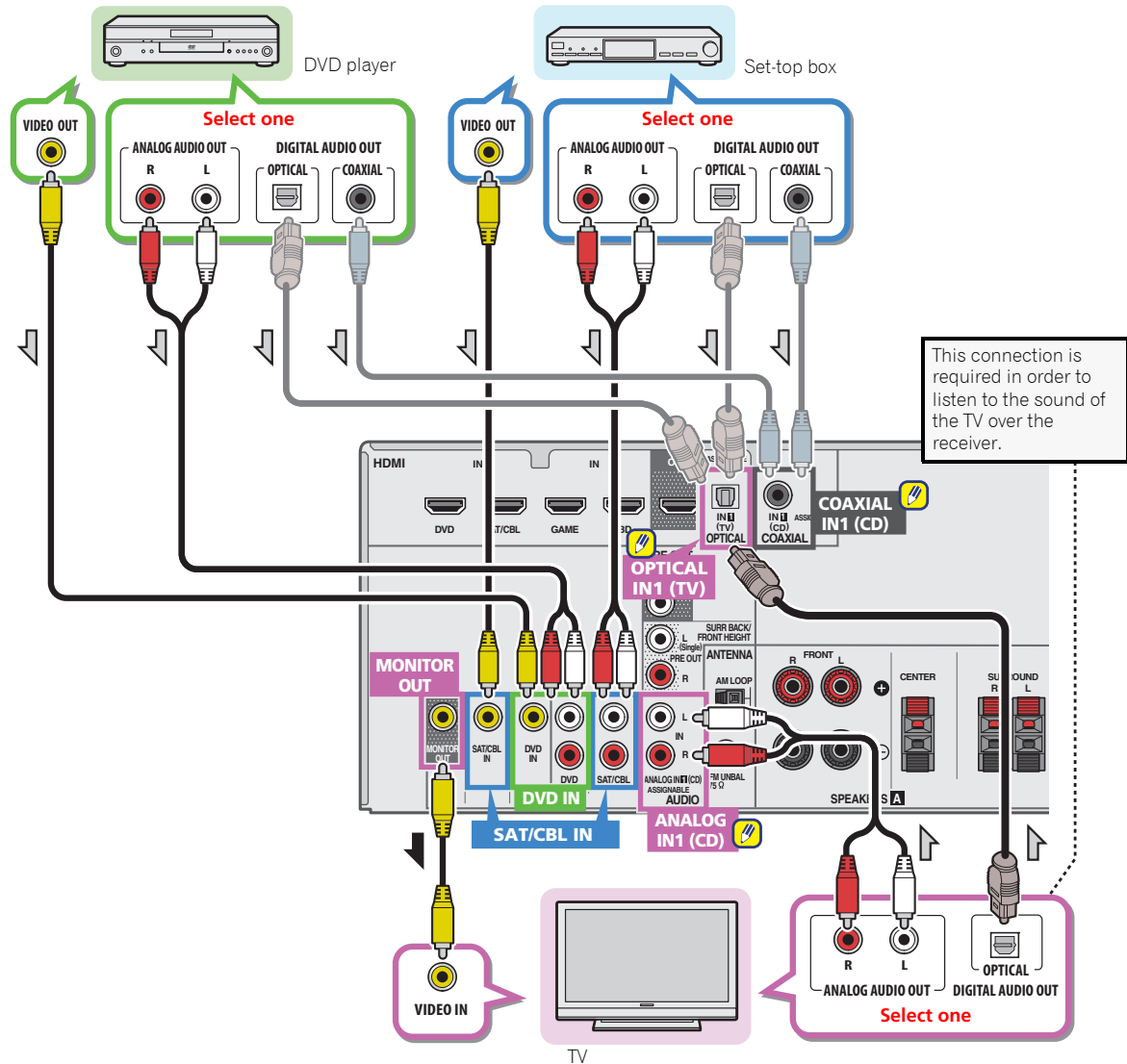

## Connecting antennas

Connect the AM loop antenna and the FM wire antenna as shown below. To improve reception and sound quality, connect external antennas (see [Using external antennas below](#)).

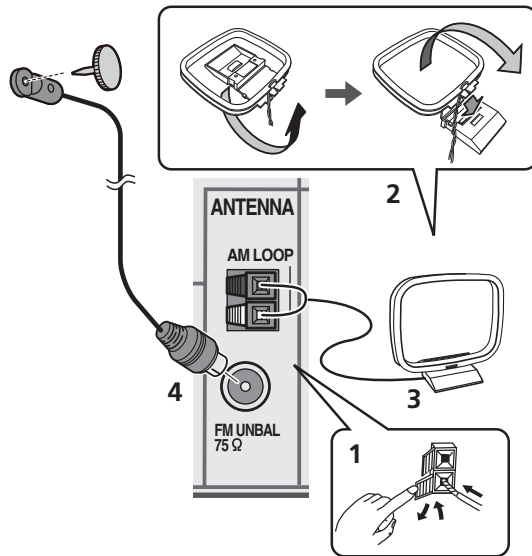

**1** Push open the tabs, then insert one wire fully into each terminal, then release the tabs to secure the AM antenna wires.

**2** Fix the AM loop antenna to the attached stand.

To fix the stand to the antenna, bend in the direction indicated by the arrow then clip the loop onto the stand.

**3** Place the AM antenna on a flat surface and in a direction giving the best reception.

**4** Connect the FM wire antenna into the FM antenna socket.

For best results, extend the FM antenna fully and fix to a wall or door frame. Don't drape loosely or leave coiled up.

## Using external antennas

### To improve FM reception

Connect an external FM antenna as shown below.

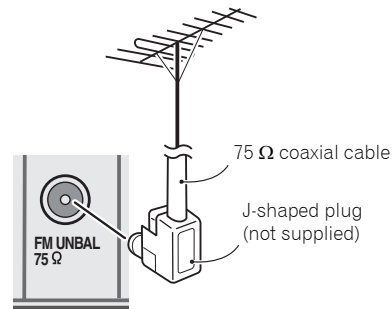

### To improve AM reception

Connect a 5 m to 6 m length of vinyl-coated wire to the AM antenna terminal without disconnecting the supplied AM loop antenna.

For the best possible reception, suspend horizontally outdoors.

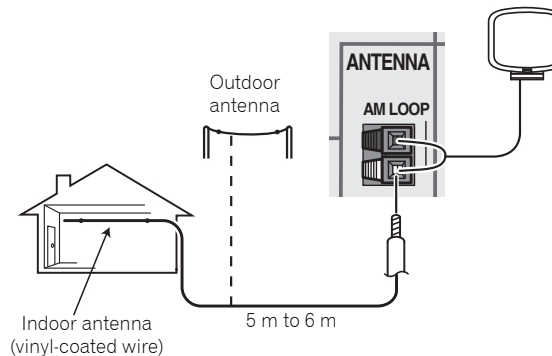

## Connecting an iPod

This receiver has a dedicated iPod terminal that will allow you to control playback of audio content from your iPod using the controls of this receiver.

► **Switch the receiver into standby, and then use the USB cable (for iPod connection) to connect your iPod to the iPod iPhone USB terminal on the front panel of this receiver.**

- The USB cable (for iPod connection) is not included with this receiver. For the cable connection, refer to also the operating instructions for iPod.
- For instructions on playing the iPod, see [Playing an iPod on page 22](#).

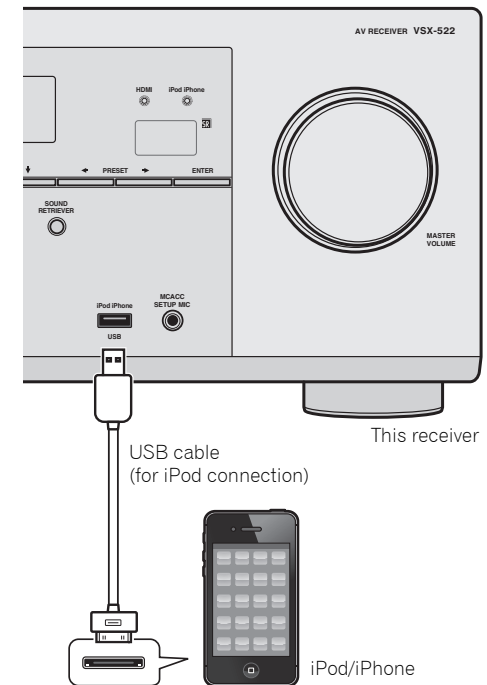



- When the ARC function is **ON** and the receiver is connected to a compatible TV with an HDMI cable, and you switch the input of the TV when the receiver's selection is **iPod/USB** input, the receiver may automatically switch to **TV**. If this happens, switch the receiver's input back to the original input, or turn **OFF** the ARC function (see [The HDMI Setup menu on page 33](#)).

## Connecting a USB device

It is possible to listen to two-channel audio using the USB interface on the front of this receiver.

### ▶ Switch the receiver into standby then connect your USB device to the USB terminal on the front panel of this receiver.

- This receiver does not support a USB hub.
- For instructions on playing the USB device, see [Playing a USB device on page 23](#).

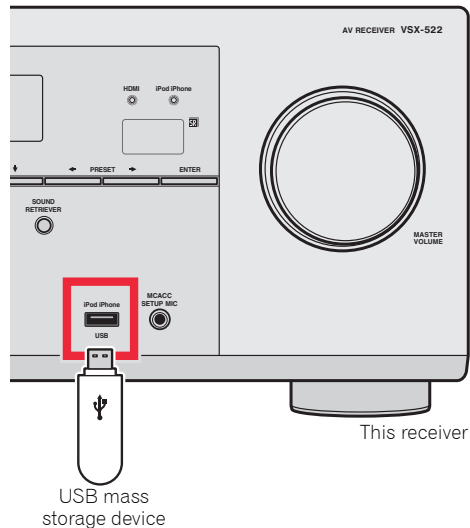

## Plugging in the receiver

Only plug in after you have connected all your components to this receiver, including the speakers.

### ⚠ CAUTION

- Handle the power cord by the plug part. Do not pull out the plug by tugging the cord, and never touch the power cord when your hands are wet, as this could cause a short circuit or electric shock. Do not place the unit, a piece of furniture, or other object on the power cord or pinch the cord in any other way. Never make a knot in the cord or tie it with other cables. The power cords should be routed so that they are not likely to be stepped on. A damaged power cord can cause a fire or give you an electric shock. Check the power cord once in a while. If you find it damaged, ask your nearest Pioneer authorized independent service company for a replacement.
- Do not use any power cord other than the one supplied with this unit.
- Do not use the supplied power cord for any purpose other than that described below.
- The receiver should be disconnected by removing the mains plug from the wall socket when not in regular use, e.g., when on vacation.

### 📌 Note

- After this receiver is connected to an AC outlet, a 2 second to 10 second HDMI initialization process begins. You cannot carry out any operations during this process. The **HDMI** indicator in the front panel display blinks during this process, and you can turn on this receiver once it has stopped blinking. When you set **ARC** at HDMI setup to **OFF**, you can skip this process. For details, see [The HDMI Setup menu on page 33](#).

- 1 Plug the supplied power cord into the **AC IN** socket on the back of the receiver.
- 2 Plug the other end into a power outlet.

### Before setting up

This receiver allows you to adjust the system setup, using the on-screen display (OSD) that is shown on the TV screen.

- The OSD will not appear if you have connected using the HDMI output to your TV. Use composite connections for system setup.

First, follow the procedure below to make sure that the OSD screen is displayed.

- 1 Switch on the receiver and your TV.
- 2 Switch the TV input to the input that connects this receiver to the TV through the corresponding composite video cable.

For example, if you connected this receiver to the **VIDEO** jacks on your TV, make sure that the **VIDEO** input is now selected.

- 3 Press **RECEIVER** on the remote control, then press the **HOME MENU** button.

The Home Menu of the OSD screen will be displayed on the TV. If nothing appears on the screen, try to change the TV format setting on the receiver (see below).

### Changing the TV format setting

If the OSD screen is not displayed correctly, it may be that the TV system is set incorrectly for your country or region.

- 1 Switch the receiver into standby.
- 2 While holding down the **TUNE**  $\uparrow$  button, press and hold the  $\odot$  **STANDBY/ON** button for about two seconds.

The display shows the new setting (**PAL** or **NTSC**).

### Canceling the demo display

The display on the front panel shows various information (demo displays) when the receiver is not operating.

You can turn off the demo display. For details, see [The FL Demo Mode menu on page 33](#).

- The demo mode is canceled automatically when the Auto MCACC setup is performed (see below).

### Automatically setting up for surround sound (MCACC)

The Auto Multi-Channel Acoustic Calibration (MCACC) setup measures the acoustic characteristics of your listening area, taking into account ambient noise, speaker size and distance, and tests for both channel delay and channel level. After you have set up the microphone provided with your system, the receiver uses the information from a series of test tones to optimize the speaker settings and equalization for your particular room.

#### ⚠ CAUTION

- The test tones used in the Auto MCACC setup are output at high volume.

#### 👤 Important

- The OSD will not appear if you have connected using the HDMI output to your TV. Use composite connections for Auto MCACC setup.
- The Auto MCACC setup will overwrite any existing speaker settings you've made.
- Before using the Auto MCACC setup, the **iPod/USB** input should not be selected as an input source.
- If you connected either the surround back speaker or the front height speaker, make sure that the Pre Out setting is correctly set before performing the Auto MCACC setup (see [page 33](#)). (Here is an explanation using the OSD screen for a surround back speaker connection.)

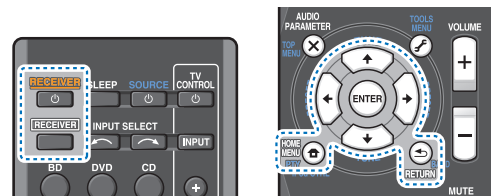

- 1 Switch on the receiver and your TV.
- 2 Switch the TV input to the input that connects this receiver to the TV through the corresponding composite cable.

- 3 Connect the microphone to the MCACC SETUP MIC jack on the front panel.

Make sure there are no obstacles between the speakers and the microphone.

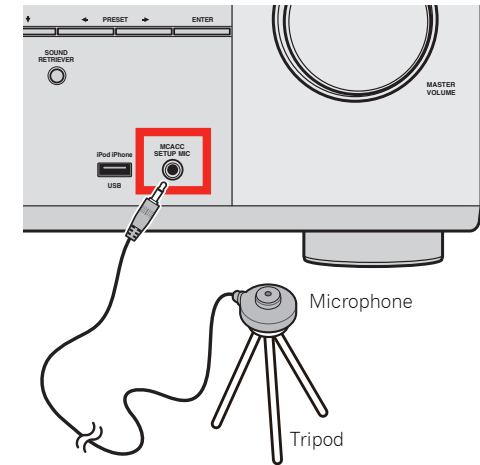

If you have a tripod, use it to place the microphone so that it's about ear level at your normal listening position. Otherwise, place the microphone at ear level using a table or a chair.

- 4 Press **RECEIVER** on the remote control, then press the **HOME MENU** button.

The Home Menu appears on your TV. Use  $\uparrow/\downarrow/\leftarrow/\rightarrow$  and **ENTER** on the remote control to navigate through the screens and select menu items. Press **RETURN** to exit the current menu.

- Press **HOME MENU** at any time to exit the Home Menu. If you cancel the Auto MCACC setup at any time, the receiver automatically exits and no settings will be made.
- The screensaver automatically starts after three minutes of inactivity.

- 5** Select 'Auto MCACC' from the Home Menu, then press **ENTER**.

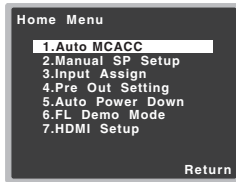

- **Mic In!** blinks when the microphone is not connected to MCACC SETUP MIC jack.

Try to be as quiet as possible after pressing **ENTER**. The system outputs a series of test tones to establish the ambient noise level.

- 6** Follow the instructions on-screen.

- Make sure the microphone is connected.
- Make sure the subwoofer is on and the volume is turned up.
- When using surround back or front height speakers, turn on the power to the amplifier to which the surround back or front height speakers are connected, and adjust the sound level to the desired level.
- See below for notes regarding background noise and other possible interference.

- 7** Wait for the test tones to finish.

A progress report is displayed on-screen while the receiver outputs test tones to determine the speakers present in your setup. Try to be as quiet as possible while it's doing this.

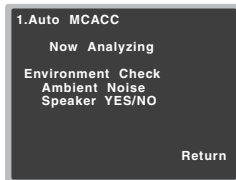

- For correct speaker settings, do not adjust the volume during the test tones.

- 8** Confirm the speaker configuration.

The configuration shown on-screen should reflect the actual speakers you have.

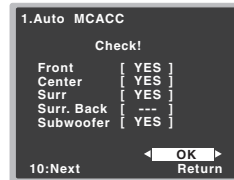

- With error messages (such as **Too much ambient noise**) select **RETRY** after checking for ambient noise (see [Other problems when using the Auto MCACC setup below](#)).

If the speaker configuration displayed isn't correct, use **↑/↓** to select the speaker and **←/→** to change the setting. When you're finished, go to the next step.

If you see an error message (**ERR**) in the right side column, there may be a problem with the speaker connection. If selecting **RETRY** doesn't fix the problem, turn off the power and check the speaker connections.

- 9** Make sure 'OK' is selected, then press **ENTER**.

If the screen in step 8 is left untouched for 10 seconds and **ENTER** is not pressed in step 9, the Auto MCACC setup will start automatically as shown.

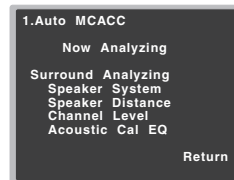

A progress report is displayed on-screen while the receiver outputs more test tones to determine the optimum receiver settings for channel level, speaker distance, and Acoustic Calibration EQ.

Again, try to be as quiet as possible while this is happening. It may take 1 to 3 minutes.

- 10** The Auto MCACC setup has finished! You return to the Home Menu.

The settings made in the Auto MCACC setup should give you excellent surround sound from your system, but it is also possible to adjust these settings manually using the Home Menu (starting on [page 30](#)).

#### Note

- Depending on the characteristics of your room, sometimes identical speakers with cone sizes of around 12 cm will end up with different size settings. You can correct the setting manually using the [Speaker Setting on page 30](#).
- The subwoofer distance setting may be farther than the actual distance from the listening position. This setting should be accurate (taking delay and room characteristics into account) and generally does not need to be changed.

#### Other problems when using the Auto MCACC setup

If the room environment is not optimal for the Auto MCACC setup (too much background noise, echo off the walls, obstacles blocking the speakers from the microphone) the final settings may be incorrect. Check for household appliances (air conditioner, fridge, fan, etc.), that may be affecting the environment and switch them off if necessary. If there are any instructions showing in the front panel display, please follow them.

- Some older TVs may interfere with the operation of the microphone. If this seems to be happening, switch off the TV when doing the Auto MCACC setup.

## Playing a source

Here are the basic instructions for playing a source (such as a DVD disc) with your home theater system.

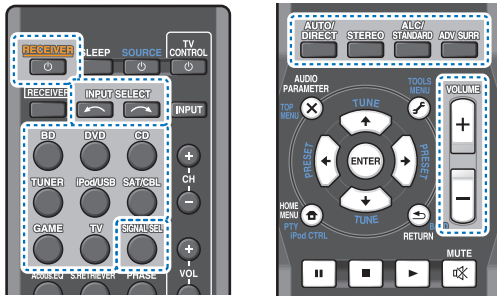

### 1 Switch on your system components and receiver.

Start by switching on the playback component (for example a DVD player), your TV and subwoofer (if you have one), then the receiver (press **RECEIVER**).

- Make sure the setup microphone is disconnected.

### 2 Switch the TV input to the input that connects this receiver.

For example, if you connected this receiver to the **VIDEO** jacks on your TV, make sure that the **VIDEO** input is now selected.

### 3 Press input function buttons to select the input function you want to play.

- The input of the receiver will switch over, and you will be able to operate other components using the remote control. To operate the receiver, first press **RECEIVER** on the remote control, then press the appropriate button to operate.
- The input source can also be selected by using **INPUT SELECT** buttons on the remote control, or by using the front panel **INPUT SELECTOR** dial. In this case, the remote control won't switch operational modes.

If you selected the proper input source and there is still no sound, select the audio input signal for playback (see [Selecting the audio input signal below](#)).

### 4 Press **AUTO/DIRECT** to select 'AUTO SURROUND' and start playback of the source.

If you're playing a Dolby Digital or DTS surround sound DVD disc, with a digital audio connection, you should hear surround sound. If you're playing a stereo source or if the connection is an analog audio connection, you will only hear sound from the front left/right speakers in the default listening mode.

It is possible to check on the front panel display whether or not surround sound playback is being performed properly.

When using a surround back speaker, **DOD+PLIIx** is displayed when playing Dolby Digital 5.1-channel signals, and **DTS+NEO:6** is displayed when playing DTS 5.1-channel signals.

When not using a surround back speaker, **DOD** is displayed when playing Dolby Digital signals.

If the display does not correspond to the input signal and listening mode, check the connections and settings.

#### Note

- You may need to check the digital audio output settings on your DVD player or digital satellite receiver. It should be set to output Dolby Digital, DTS and 88.2 kHz/96 kHz PCM (2 channel) audio, and if there is an MPEG audio option, set this to convert the MPEG audio to PCM.
- Depending on your DVD player or source discs, you may only get digital 2 channel stereo and analog sound. In this case, the receiver must be set to a multichannel listening mode if you want multichannel surround sound.

### 5 Use **VOLUME +/-** to adjust the volume level.

Turn down the volume of your TV so that all sound is coming from the speakers connected to this receiver.

## Selecting the audio input signal

The audio input signal can be selected for each input source. Once it is set, the audio input that was selected will be applied whenever you select the input source using the input function buttons.

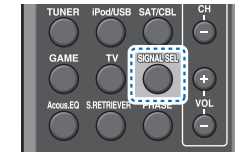

### Press **SIGNAL SEL** to select the audio input signal corresponding to the source component.

Each press cycles through the following:

- **H** – Selects an HDMI signal. **H** can be selected for **BD**, **DVD**, **SAT/CBL** or **GAME** input. For other inputs, **H** cannot be selected.
  - When the **HDMI** option in [Setting the Audio options on page 28](#) is set to **THRU**, the sound will be heard through your TV, not from this receiver.
- **A** – Selects the analog inputs.
- **C1/O1** – Selects the digital input. The coaxial 1 input is selected for **C1**, and the optical 1 audio input is selected for **O1**.

When **H** (HDMI) or **C1/O1** (digital) is selected and the selected audio input is not provided, **A** (analog) is automatically selected.

#### Note

- **BD** and **GAME** inputs are fixed to **H** (HDMI). It cannot be changed.
- For the **TV** input, only **A** (analog) or **C1/O1** (digital) can be selected. However, if the **ARC at HDMI Setup** is set to **ON**, the input is fixed to **H** (HDMI) and cannot be changed.
- When set to **H** (HDMI) or **C1/O1** (digital), **DD** lights when a Dolby Digital signal is input, and **DTS** lights when a DTS signal is input.
- When the **H** (HDMI) is selected, the **A** and **DIGITAL** indicators are off (see [page 7](#)).

- When digital input (optical or coaxial) is selected, this receiver can only play back Dolby Digital, PCM (32 kHz to 96 kHz) and DTS (including DTS 96 kHz/24 bit) digital signal formats. The compatible signals via the HDMI terminals are: Dolby Digital, DTS, SACD (DSD 2 ch only), PCM (32 kHz to 192 kHz sampling frequencies), Dolby TrueHD, Dolby Digital Plus, DTS-EXPRESS, DTS-HD Master Audio and DVD Audio (including 192 kHz). With other digital signal formats, set to **A** (analog).
- You may get digital noise when a LD or CD player compatible with DTS is playing an analog signal. To prevent noise, make the proper digital connections ([page 13](#)) and set the signal input to **C1/O1** (digital).
- Some DVD players don't output DTS signals. For more details, refer to the instruction manual supplied with your DVD player.

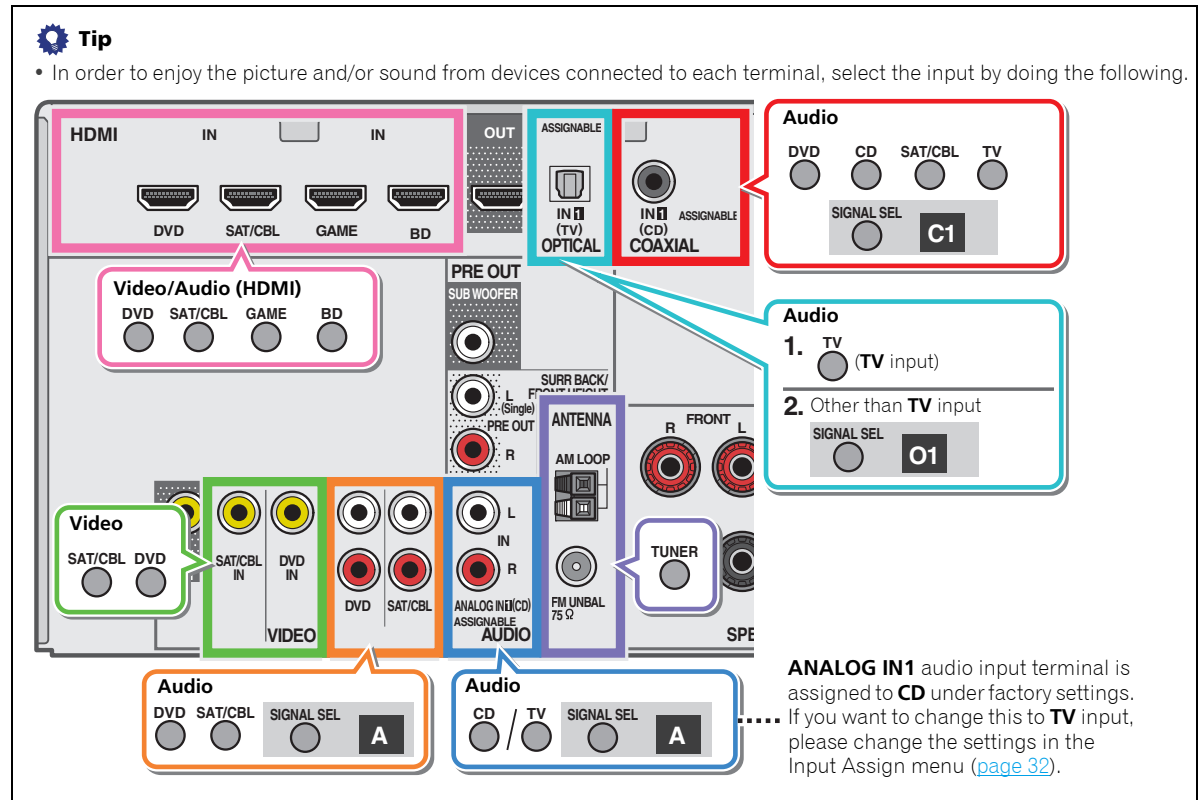

## Playing an iPod

This receiver has a dedicated iPod terminal that will allow you to control playback of audio content from your iPod using the controls of this receiver.

### Important

- Pioneer cannot under any circumstances accept responsibility for any direct or indirect loss arising from any inconvenience or loss of recorded material resulting from the iPod failure.

### Note

- This receiver is compatible with the audio of the iPod touch (1st/2nd/3rd/4th generation), iPod classic, iPod nano (3rd/4th/5th/6th generation), iPhone 3G, iPhone 3GS, iPhone 4 and iPhone 4S (iPod shuffle not supported). However, that some of the functions may be restricted for some models.
- This receiver has been developed and tested for the software version of iPod/iPhone indicated on the website of Pioneer (<http://pioneer.jp/homeav/support/ios/ao/>).
- Installing software versions other than indicated on the website of Pioneer to your iPod/iPhone may result in incompatibility with this receiver.
- iPod and iPhone are licensed for reproduction of non-copyrighted materials or materials the user is legally permitted to reproduce.
- Features such as the equalizer cannot be controlled using this receiver, and we recommend switching the equalizer off before connecting.

## 1 Switch on the receiver and your TV.

See [Connecting an iPod on page 16](#).

## 2 Switch the TV input so that it connects to the receiver.

- Switch the TV input to the input that connects this receiver to the TV through the corresponding composite cable.

## 3 Press iPod/USB to switch the receiver to the iPod/USB input.

The front panel display shows **Loading** while the receiver verifies the connection and retrieves data from the iPod.

## 4 Use TOP MENU to display iPod Top menu.

When the display shows **Top Menu** you're ready to play music from the iPod.

- If after pressing **iPod/USB** the display shows **NO DEVICE**, try switching off the receiver and reconnecting the iPod to the receiver.
- The controls of your iPod will be inoperable when connected to this receiver.

## Playing back files stored on an iPod

To navigate songs on your iPod, you can take advantage of the OSD of your TV connected to this receiver. You can also control all operations for music in the front panel display of this receiver.

- Note that non-roman characters in the title are displayed as '\*'. \*
- This feature is not available for photos or video clips on your iPod.

## Finding what you want to play

When your iPod is connected to this receiver, you can browse songs stored on your iPod by playlist, artist, album name, song name, genre or composer, similar to using your iPod directly.

## 1 Use ↑/↓ to select a category, then press ENTER to browse that category.

- To return to the previous level any time, press **RETURN**.

## 2 Use ↑/↓ to browse the selected category (e.g., albums).

- Use ←/→ to move to previous/next levels.

## 3 Continue browsing until you arrive at what you want to play, then press ► to start playback.

### Tip

- If you're in the song category, you can also press **ENTER** to start playback.
- You can play all of the songs in a particular category by selecting the **All** item at the top of each category list. For example, you can play all the songs by a particular artist.

## Basic playback controls

This receiver's remote control buttons can be used for basic playback of files stored on an iPod.

- Press **iPod/USB** to switch the remote control to the iPod/USB operation mode.

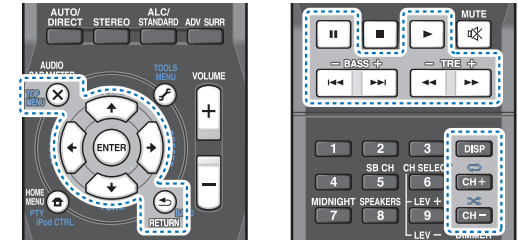

- During Audiobook playback, press ↑/↓ to switch the playback speed: Faster ↔ Normal ↔ Slower

## Switches between the iPod controls and the receiver controls

This allows you to switch between performing iPod operations via the receiver remote control or on the iPod itself.

### Press iPod CTRL to switch to the iPod controls.

- Press **iPod CTRL** again to switch back to the receiver controls when you're done.

## Playing a USB device

It is possible to listen to two-channel audio using the USB interface on the front of this receiver.

### Important

- Pioneer cannot guarantee compatibility (operation and/or bus power) with all USB mass storage devices and assumes no responsibility for any loss of data that may occur when connected to this receiver.

### Note

- This includes playback of WMA/MP3/MPEG-4 AAC files (except files with copy-protection or restricted playback).
- Compatible USB devices include external magnetic hard drives, portable flash memory (particularly keydrives) and digital audio players (MP3 players) of format FAT16/32. It is not possible to connect this receiver to a personal computer for USB playback.
- With large amounts of data, it may take longer for the receiver to read the contents of a USB device.
- If the file selected cannot be played back, this receiver automatically skips to the next file playable.
- When the file currently being played back has no title assigned to it, the file name is displayed in the OSD instead; when neither the album name nor the artist name is present, the row is displayed as a blank space.
- Note that non-roman characters in the playlist are displayed as '\*'. \*
- Make sure the receiver is in standby when disconnecting the USB device.

## 1 Switch on the receiver and your TV.

See [Connecting a USB device on page 17](#).

## 2 Switch the TV input so that it connects to the receiver.

- Switch the TV input to the input that connects this receiver to the TV through the corresponding composite cable.

## 3 Press iPod/USB on the remote control to switch the receiver to the iPod/USB input.

**Loading** appears in the OSD as this receiver starts recognizing the USB device connected. After the recognition, a playback screen appears in the OSD and playback starts automatically.

## Basic playback controls

This receiver's remote control buttons can be used for basic playback of files stored on USB devices.

- Press **iPod/USB** to switch the remote control to the iPod/USB operation mode.

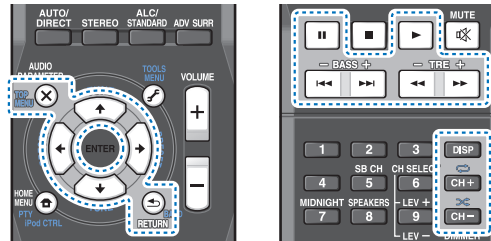

### Important

If a **USB Error** message lights in the display, try following the points below:

- Switch the receiver off, then on again.
- Reconnect the USB device with the receiver switched off.
- Select another input source (like **BD**), then switch back to **iPod/USB**.
- Use a dedicated AC adapter (supplied with the device) for USB power.

For more information on error messages, see [USB messages on page 36](#).

If this doesn't remedy the problem, it is likely your USB device is incompatible.

## Compressed audio compatibility

Note that although most standard bit/sampling rate combinations for compressed audio are compatible, some irregularly encoded files may not play back. The list below shows compatible formats for compressed audio files:

- MP3** (MPEG-1/2/2.5 Audio Layer 3) – Sampling rates: 32 kHz/44.1 kHz/48 kHz; Bit rates: 32 kbps to 320 kbps (128 kbps or higher recommended); File extension: **.mp3**
- WMA** (Windows Media Audio) – Sampling rates: 32 kHz/44.1 kHz/48 kHz; Bit rates: 48 kbps to 192 kbps (128 kbps or higher recommended); File extension: **.wma**; WMA9 Pro and WMA lossless encoding: No
- AAC** (MPEG-4 Advanced Audio Coding) – Sampling rates: 32 kHz/44.1 kHz/48 kHz; Bit rates: 16 kbps to 320 kbps (128 kbps or higher recommended); File extension: **.m4a**; Apple lossless encoding: No

## Other compatibility information

- VBR** (variable bit rate) MP3/WMA/MPEG-4 AAC playback: Yes (Note that in some cases playback time will not be displayed correctly.)
- DRM** (Digital Rights Management) protection compatible: Yes (DRM-protected audio files will not play in this receiver.)

## About MPEG-4 AAC

Advanced Audio Coding (AAC) is at the core of the MPEG-4 AAC standard, which incorporates MPEG-2 AAC, forming the basis of the MPEG-4 audio compression technology. The file format and extension used depend on the application used to encode the AAC file. This receiver plays back AAC files encoded by iTunes® bearing the extension **'m4a'**. DRM-protected files will not play, and files encoded with some versions of iTunes® may not play.

*Apple and iTunes are trademarks of Apple Inc., registered in the U.S. and other countries.*

## About WMA

WMA is an acronym for Windows Media Audio and refers to an audio compression technology developed by Microsoft Corporation. This receiver plays back WMA files encoded using Windows Media® Player bearing the extension **'wma'**. Note that DRM-protected files will not play, and files encoded with some versions of Windows Media® Player may not play.

## Listening to the radio

The following steps show you how to tune in to FM and AM radio broadcasts using the automatic (search) and manual (step) tuning functions. Once you are tuned to a station you can memorize the frequency for recall later—see [Saving station presets below](#) for more on how to do this.

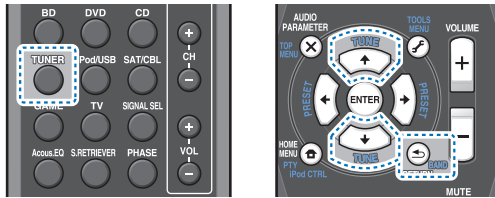

- 1 Press **TUNER** to select the tuner.
- 2 Use **BAND** to change the band (FM or AM), if necessary. Each press switches the band between FM (stereo or mono) and AM.
- 3 Tune to a station.

There are three ways to do this:

### ❖ Automatic tuning

To search for stations in the currently selected band, press and hold **TUNE**  $\uparrow/\downarrow$  for about a second. The receiver will start searching for the next station, stopping when it has found one. Repeat to search for other stations.

### ❖ Manual tuning

To change the frequency one step at a time, press **TUNE**  $\uparrow/\downarrow$ .

### ❖ High speed tuning

Press and hold **TUNE**  $\uparrow/\downarrow$  for high speed tuning. Release the button at the frequency you want.

## Improving FM sound

If the **TUNE** or **ST** indicators don't light when tuning to an FM station because the signal is weak, set the receiver to the mono reception mode.

### ▶ Press **BAND** to select FM MONO.

This should improve the sound quality and allow you to enjoy the broadcast.

## Saving station presets

If you often listen to a particular radio station, it's convenient to have the receiver store the frequency for easy recall whenever you want to listen to that station. This saves the effort of manually tuning in each time. This unit can memorize up to 30 stations.

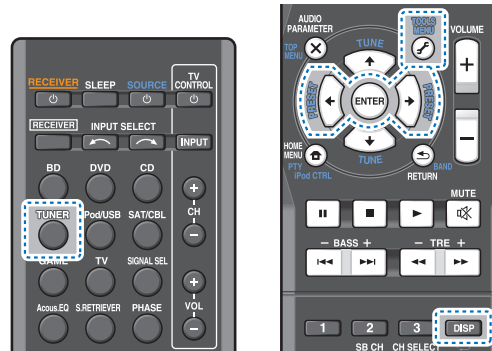

- 1 Tune to a station you want to memorize. See [Listening to the radio above](#) for more on this.
- 2 Press **TOOLS**. The display shows **PRESET**, then a blinking **MEM** and station preset.
- 3 Press **PRESET**  $\leftarrow/\rightarrow$  to select the station preset you want. You can also use the number buttons.
- 4 Press **ENTER**. The preset number stop blinking and the receiver stores the station.

### 📌 Note

- If the receiver is left disconnected from the AC power outlet for over a month, the station memories will be lost and will have to be reprogrammed.
- Stations are stored in stereo. When the station is stored in the FM MONO mode, it shows as **ST** when recalled.

## Listening to station presets

You will need to have some presets stored to do this. See [Saving station presets above](#) if you haven't done this already.

- ▶ Press **PRESET**  $\leftarrow/\rightarrow$  to select the station preset you want.
  - You can also use the number buttons on the remote control to recall the station preset.

## Naming preset stations

For easier identification, you can name all of your preset stations.

- 1 Choose the station preset you want to name. See [Listening to station presets above](#) for how to do this.
- 2 Press **TOOLS** twice. The cursor at the first character position is blinking on the display.
- 3 Input the name you want. Choose a name up to eight characters long.
  - Use **PRESET**  $\leftarrow/\rightarrow$  to select character position.
  - Use **TUNE**  $\uparrow/\downarrow$  to select characters.
  - The name is stored when **ENTER** is pressed.

### ⚙️ Tip

- To erase a station name, follow steps 1 and 2, and press **ENTER** while the display is blank. Press **TOOLS** while the display is blank, to keep the previous name.
- Once you have named a station preset, Press **DISP** to show the name. When you want to return to the frequency display, press **DISP** several times to show the frequency.

## Changing the radio frequency step

If you find that you can't tune into stations successfully, the frequency step may not be suitable for your country/region. Here's how to switch the setting:

- 1 Switch the receiver into standby.
- 2 While holding down **TUNE**  $\downarrow$  button, press and hold  $\odot$  **STANDBY/ON** button for about two seconds.
  - The channel tuning step alternates between **10K STEP** and **9K STEP** each time you do this.



## Choosing the listening mode

This receiver offers a variety of listening modes to accommodate playback of various audio formats. Choose one according to your speaker environment or the source.

- While listening to a source, press the listening mode button repeatedly to select a listening mode you want.

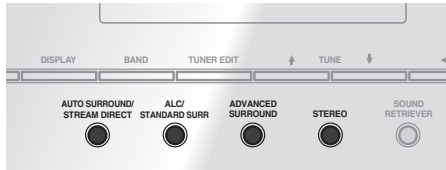
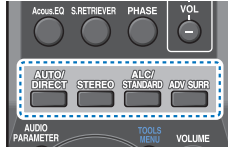

- The listening mode is shown on the display on the front panel.

### Important

- The listening modes and many features described in this section may not be available depending on the current source, settings and status of the receiver.

## Auto playback



The simplest, most direct listening option is the **AUTO SURROUND** feature. With this, the receiver automatically detects what kind of source you're playing and selects multichannel or stereo playback as necessary.

- Press **AUTO/DIRECT** repeatedly until **AUTO SURROUND** shows briefly in the display (it will then show the decoding or playback format). Check the digital format indicators in the display to see how the source is being processed.

### Note

- Stereo surround (matrix) formats are decoded accordingly using **NEO:6 CINEMA** or **DOLBY PLIix MOVIE** (see [Listening in surround sound below](#) for more on these decoding formats).

## Listening in surround sound



Using this receiver, you can listen to any source in surround sound. However, the options available will depend on your speaker setup and the type of source you're listening to.

- If the source is Dolby Digital, DTS, or Dolby Surround encoded, the proper decoding format will automatically be selected and shows in the display.

When you select **STEREO ALC** (Auto Level Control stereo mode), this unit equalizes playback sound levels if each sound level varies with the music source recorded in a portable audio player.

When you select **STEREO**, you will hear the source through just the front left and right speakers (and possibly your subwoofer depending on your speaker settings). Dolby Digital and DTS multichannel sources are downmixed to stereo.

The following modes provide basic surround sound for stereo and multichannel sources.

### Explanatory notes

No: No connected / Yes: Connected / Two: Two speakers are connected / -: Whether connected or no

Type of surround modes	Suitable sources	Surround back speaker(s)	Front height speakers
<b>Two channel sources</b>			
<b>STEREO ALC</b>	See above.	–	–
<b>DOLBY PLIix MOVIE</b>	Movie	Yes <sup>a</sup>	No
<b>DOLBY PLII MOVIE</b>		No	–
<b>DOLBY PLIix MUSIC<sup>b</sup></b>	Music	Yes <sup>a</sup>	No
<b>DOLBY PLII MUSIC<sup>b</sup></b>		No	–
<b>DOLBY PLIix GAME</b>	Video games	Yes <sup>a</sup>	No
<b>DOLBY PLII GAME</b>		No	–
<b>DOLBY PLIiz HEIGHT<sup>c</sup></b>	Movie/Music	No	Yes
<b>NEO:6 CINEMA<sup>d</sup></b>	Movie	–	–
<b>NEO:6 MUSIC<sup>d</sup></b>	Music	–	–
<b>DOLBY PRO LOGIC</b>	Old movies	–	–
Straight Decode <sup>e</sup>	No additional effects	No	–
<b>STEREO<sup>f</sup></b>	See above.	–	–
<b>Multichannel sources</b>			
<b>STEREO ALC</b>	See above.	–	–
<b>DOLBY PLIix MOVIE</b>	Movie	Two	No
<b>DOLBY PLIix MUSIC<sup>b</sup></b>	Music	Yes	No
<b>DOLBY DIGITAL EX</b>	Movie/Music	Yes	No
<b>DTS-ES</b>	Movie/Music	Yes	No
<b>DTS NEO:6</b>	Movie/Music	Yes	No
<b>DOLBY PLIiz HEIGHT</b>	Movie/Music	No	Yes
Straight Decode <sup>e</sup>	No additional effects	–	–
<b>STEREO<sup>f</sup></b>	See above.	–	–

- a. If surround back channel processing ([page 27](#)) is switched off, or the surround back speakers are set to **NO**, **DOLBY PLIix** becomes **DOLBY PLII** (5.1 channel sound).

- b. You can also adjust the **C.WIDTH**, **DIMEN.**, and **PNRM**. effect (see [Setting the Audio options on page 28](#)).
- c. You can also adjust the **H.GAIN** effect (see [Setting the Audio options on page 28](#)).
- d. You can also adjust the **C.IMG** effect (see [Setting the Audio options on page 28](#)).
- e. Cannot be selected when the **Pre Out** is set to **Surr. Back** (see [The Pre Out Setting on page 33](#)).
- f. • You can choose the **STEREO** mode by using **STEREO** button.  
• The audio is heard with your surround settings and you can still use the Midnight, Loudness, Phase Control, Sound Retriever and Tone functions.

### Note

- In modes that give 6.1 channel sound, the same signal is heard from both surround back speakers.

### Using the Advanced surround



The Advanced surround feature creates a variety of surround effects. Try different modes with various soundtracks to see which you like.

<b>ACTION</b>	Designed for action movies with dynamic soundtracks.
<b>DRAMA</b>	Designed for movies with lots of dialog.
<b>ENT.SHOW</b>	Suitable for musical sources.
<b>ADVANCED GAME</b>	Suitable for video games.
<b>SPORTS</b>	Suitable for sports programs.
<b>CLASSICAL</b>	Gives a large concert hall-type sound
<b>ROCK/POP</b>	Creates a live concert sound for rock and/or pop music.
<b>UNPLUGGED</b>	Suitable for acoustic music sources.
<b>EXT.STEREO</b>	Gives multichannel sound to a stereo source, using all of your speakers

### F.S.S.ADVANCE

(Front Stage Surround ADVANCE)

Allows you to create natural surround sound effects using just the front speakers and the subwoofer. Use to provide a rich surround sound effect directed to the center of where the front left and right speakers sound projection area converges.

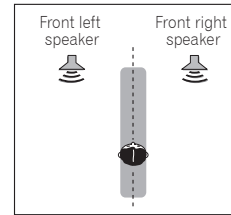

### PHONES SURR

When listening through headphones, you can still get the effect of overall surround

### Using Stream Direct



Use the Stream Direct modes when you want to hear the truest possible reproduction of a source. All unnecessary signal processing is bypassed.

**AUTO SURROUND** See [Auto playback on page 25](#).

### DIRECT

Sources are heard according to the settings made in the Manual SP Setup (speaker setting, channel level, speaker distance), as well as with dual mono settings. You will hear sources according to the number of channels in the signal. Phase Control, Acoustic Calibration EQ, Sound Delay, Auto Delay, LFE Attenuate and Center image functions are available.

### PURE DIRECT

Analog and PCM sources are heard without any digital processing.

### Using the Sound Retriever

When audio data is removed during the compression process, sound quality often suffers from an uneven sound image. The Sound Retriever feature employs new DSP technology that helps bring CD quality sound back to compressed 2-channel audio by restoring sound pressure and smoothing jagged artifacts left over after compression.

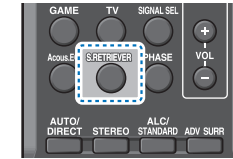

▶ Press **S.RETRIEVER** to switch the **S.RTV** (Sound Retriever) **ON** or **OFF**.

### Note

- The Sound Retriever is only applicable to 2-channel sources.

### Listening with Acoustic Calibration EQ

You can listen to sources using the Acoustic Calibration Equalization set in [Automatically setting up for surround sound \(MCACC\) on page 18](#). Refer to these pages for more on Acoustic Calibration Equalization.

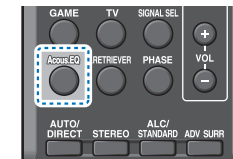

▶ While listening to a source, press **Acous.EQ** to switch the **EQ** (Acoustic Calibration EQ) **ON** or **OFF**.

The MCACC indicator on the front panel lights when Acoustic Calibration EQ is active.

- You can't use Acoustic Calibration EQ with Stream Direct mode and it has no effect with headphones.

## Better sound using Phase Control

This receiver's Phase Control feature uses phase correction measures to make sure your sound source arrives at the listening position in phase, preventing unwanted distortion and/or coloring of the sound.

Phase Control technology provides coherent sound reproduction through the use of phase matching for an optimal sound image at your listening position. The default setting is on and we recommend leaving Phase Control switched on for all sound sources.

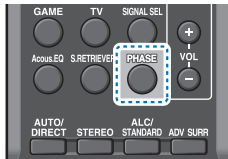

▶ Press **PHASE** to switch the P.CTL (Phase Control) ON or OFF.

### Note

- Phase matching is a very important factor in achieving proper sound reproduction. If two waveforms are 'in phase', they crest and trough together, resulting in increased amplitude, clarity and presence of the sound signal. If a crest of a wave meets a trough, then the sound will be 'out of phase' and an unreliable sound image will be produced.
- If your subwoofer has a phase control switch, set it to the plus (+) sign (or 0°). However, the effect you can actually feel when Phase Control is set to **ON** on this receiver depends on the type of your subwoofer. Set your subwoofer to maximize the effect. It is also recommended you try changing the orientation or the place of your subwoofer.
- Set the built-in lowpass filter switch of your subwoofer to OFF. If this cannot be done on your subwoofer, set the cutoff frequency to a higher value.
- If the speaker distance is not properly set, you may not have a maximized Phase Control effect.
- The Phase Control mode cannot be set to **ON** in the following cases:
  - When the **PURE DIRECT** mode is switched on.
  - When the headphones are connected.

## Using surround back channel processing

You can have the receiver automatically use 6.1 or 7.1 decoding for 6.1 encoded sources (for example, Dolby Digital EX or DTS-ES), or you can choose to always use 6.1 or 7.1 decoding (for example, with 5.1 encoded material). With 5.1 encoded sources, a surround back channel will be generated, but the material may sound better in the 5.1 format for which it was originally encoded (in which case, you can simply switch surround back channel processing off).

- With a 7.1-channel surround system, audio signals that have undergone matrix decoding processing through surround back channel processing to which the Up Mix function is added are output from the surround back speakers.



▶ Press **RECEIVER**, then press **SB CH** repeatedly to cycle the surround back channel options.

Each press cycles through the options as follows:

- **SB ON** – Matrix decoding processing for generating the surround back component from the surround component is turned on.
- **SB AUTO** – Matrix decoding processing for generating the surround back component from the surround component is switched automatically. Matrix decoding processing is only performed when surround back channel signals are detected in the input signals.
- **SB OFF** – Matrix decoding processing for generating the surround back component from the surround component is turned off.

## Setting the Up Mix function

In a 7.1-channel surround system with surround speakers placed directly at the sides of the listening position, the surround sound of 5.1-channel sources is heard from the side. The Up Mix function mixes the sound of the surround speakers with the surround back speakers so that the surround sound is heard from diagonally to the rear as it should be.

- Using the Up Mix function is effective when the speakers in the 7.1-channel surround system are set up as recommended in the example on [page 10](#).
- Depending on the positions of the speakers and the sound source, in some cases it may not be possible to achieve good results. In this case, set the setting to **OFF**.

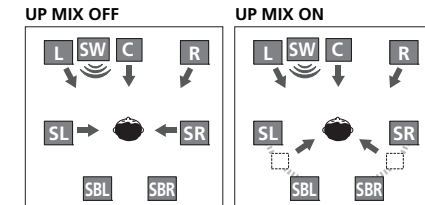

**1** Switch the receiver into standby.

**2** While holding down **PRESET** → on the front panel, and hold the **STANDBY/ON** for about two seconds.

**UP MIX: OFF** appears and the Up Mix function turns off. If you want to turn this function on, perform steps 1 and 2 again.

- When set to **ON**, the **■** (Up Mix) indicator on the front panel lights.

### Note

- Set to **ON** regardless of this setting when playing DTS-HD signals.
- May automatically be set to **OFF** even when set to **ON**, depending on the input signal and listening mode.

## Setting the Audio options

There are a number of additional sound settings you can make using the **AUDIO PARAMETER** menu. The defaults, if not stated, are listed in bold.

### Important

- Note that if a setting doesn't appear in the **AUDIO PARAMETER** menu, it is unavailable due to the current source, settings and status of the receiver.

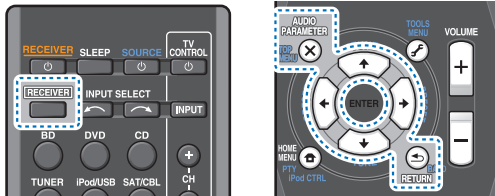

**1** Press **RECEIVER**, then press **AUDIO PARAMETER**.

**2** Use **↑/↓** to select the setting you want to adjust.

Depending on the current status/mode of the receiver, certain options may not be able to be selected. Check the table below for notes on this.

**3** Use **←/→** to set it as necessary.

See the table below for the options available for each setting.

**4** Press **RETURN** to confirm and exit the menu.

Setting/What it does	Option(s)
<b>EQ</b> (Acoustic Calibration EQ) Switches on/off the effect of Acoustic Calibration EQ.	<b>ON</b> <i>OFF</i>
<b>S.DELAY</b> (Sound Delay) Some monitors have a slight delay when showing video, so the soundtrack will be slightly out of sync with the picture. By adding a bit of delay, you can adjust the sound to match the presentation of the video.	0.0 to 9.0 (frames) <i>1 second = 25 frames (PAL)/ 30 frames (NTSC)</i> Default: <b>0.0</b>
<b>MIDNIGHT/LOUDNESS<sup>a</sup></b> The <b>MIDNIGHT</b> allows you to hear effective surround sound of movies at low volumes. The <b>LOUDNESS</b> is used to get good bass and treble from music sources at low volumes.	<b>M/L OFF</b> <i>MIDNIGHT</i> <i>LOUDNESS</i>
<b>S.RTV</b> (Sound Retriever) <sup>b</sup> When audio data is removed during the compression process, sound quality often suffers from an uneven sound image. The Sound Retriever feature employs new DSP technology that helps bring CD quality sound back to compressed 2-channel audio by restoring sound pressure and smoothing jagged artifacts left over after compression.	<b>OFF<sup>c</sup></b> <i>ON</i>
<b>DUAL MONO<sup>d</sup></b> Specifies how dual mono encoded Dolby Digital soundtracks should be played.	<b>CH1</b> – Channel 1 is heard only <b>CH2</b> – Channel 2 is heard only <b>CH1 CH2</b> – Both channels heard from front speakers
<b>F.PCM</b> (Fixed PCM) This is useful if you find there is a slight delay before <b>OFF</b> recognizes the PCM signal on a CD, for instance. When <b>ON</b> is selected, noise may be output during playback of non-PCM sources. Please select another input signal if this is a problem.	<b>OFF</b> <i>ON</i>

Setting/What it does	Option(s)
<b>DRC</b> (Dynamic Range Control) Adjusts the level of dynamic range for movie soundtracks optimized for Dolby Digital, DTS, Dolby Digital Plus, Dolby TrueHD, DTS-HD and DTS-HD Master Audio (you may need to use this feature when listening to surround sound at low volumes).	<b>AUTO<sup>e</sup></b> <i>MAX</i> <i>MID</i> <i>OFF</i>
<b>LFE ATT</b> (LFE Attenuate) Some Dolby Digital and DTS audio sources include ultra-low bass tones. Set the LFE attenuator as necessary to prevent the ultra-low bass tones from distorting the sound from the speakers. The LFE is not limited when set to 0 dB, which is the recommended value. When set to -15 dB, the LFE is limited by the respective degree. When OFF is selected, no sound is output from the LFE channel.	<b>0</b> (0 dB) <i>5 (-5 dB)</i> <i>10 (-10 dB)</i> <i>15 (-15 dB)</i> <i>20 (-20 dB)</i> <b>** (OFF)</b>
<b>SACD G.</b> (SACD Gain) <sup>f</sup> Brings out detail in SACDs by maximizing the dynamic range (during digital processing).	<b>0</b> (0 dB) <i>+6 (+6 dB)</i>
<b>HDMI</b> (HDMI Audio) Specifies the routing of the HDMI audio signal out of this receiver ( <b>AMP</b> ) or through to a TV ( <b>THRU</b> ). When <b>THRU</b> is selected, no sound is output from this receiver.	<b>AMP</b> <i>THRU</i>
<b>A.DLY</b> (Auto Delay) <sup>g</sup> This feature automatically corrects the audio-to-video delay between components connected with an HDMI cable. The audio delay time is set depending on the operational status of the display connected with an HDMI cable. The video delay time is automatically adjusted according to the audio delay time.	<b>OFF</b> <i>ON</i>
<b>C.WIDTH</b> (Center Width) <sup>h</sup> (Applicable only when using a center speaker) Spreads the center channel between the front right and left speakers, making it sound wider (higher settings) or narrower (lower settings).	0 to 7 Default: <b>3</b>

Setting/What it does	Option(s)
<b>DIMEN</b> (Dimension) <sup>h</sup> Adjusts the surround sound balance from front to back, making the sound more distant (minus settings), or more forward (positive settings).	-3 to +3 Default: <b>0</b>
<b>PNRM</b> . (Panorama) <sup>h</sup> Extends the front stereo image to include surround speakers for a 'wraparound' effect.	<b>OFF</b> <i>ON</i>
<b>C.IMG</b> (Center Image) <sup>i</sup> (Applicable only when using a center speaker) Adjust the center image to create a wider stereo effect with vocals. Adjust the effect from <b>0</b> (all center channel sent to front right and left speakers) to <b>10</b> (center channel sent to the center speaker only).	0 to 10 Default: <b>3</b> (NEO:6 MUSIC), <b>10</b> (NEO:6 CINEMA)
<b>H.GAIN</b> (Height Gain) Adjusts the output from the front height speaker when listening in <b>DOLBY PLIIz</b> <b>HEIGHT</b> mode. If set to <b>H</b> , the sound from the top will be more emphasized.	<i>L (Low)</i> <b>M</b> (Mid) <i>H (High)</i>

- a. You can change the MIDNIGHT/LOUDNESS options at any time by using **MIDNIGHT** button.
- b. You can change the Sound Retriever feature at any time by using **S.RETRIEVER** button.
- c. The default setting when the **iPod/USB** input is selected is **ON**.
- d. This setting works only with dual mono encoded Dolby Digital and DTS soundtracks.
- e. The initial set **AUTO** is only available for Dolby TrueHD signals. Select **MAX** or **MID** for signals other than Dolby TrueHD.
- f. You shouldn't have any problems using this with most SACD discs, but if the sound distorts, it is best to switch the gain setting back to **0** dB.
- g. This feature is only available when the connected display supports the automatic audio/video synchronizing capability ('lip-sync') for HDMI. If you find the automatically set delay time unsuitable, set **A.DLY** to **OFF** and adjust the delay time manually. For more details about the lip-sync feature of your display, contact the manufacturer directly.
- h. Only available with 2-channel sources in **DOLBY PLII MUSIC** mode.
- i. Only when listening to 2-channel sources in **NEO:6 CINEMA** and **NEO:6 MUSIC** mode.



## Using the Home Menu

The following section shows you how to make detailed settings to specify how you're using the receiver, and also explains how to fine-tune individual speaker system settings to your liking.

### Important

- The OSD will not appear if you have connected using the HDMI output to your TV. Use composite connections for Home Menu.
- If headphones are connected to the receiver, disconnect them.
- You can't use the Home Menu when the iPod/USB input is selected.

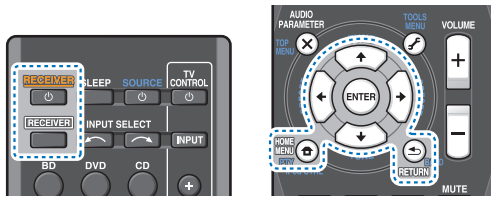

### 1 Switch on the receiver and your TV.

Press **RECEIVER** to switch on.

### 2 Switch the TV input to the input that connects this receiver to the TV through the corresponding composite cable.

### 3 Press **RECEIVER**, then press **HOME MENU**.

The Home Menu appears on your TV. Use **↑/↓/←/→** and **ENTER** on the remote control to navigate through the screens and select menu items. Press **RETURN** to exit the current menu.

- Press **HOME MENU** at any time to exit the Home Menu.

### 4 Select the setting you want to adjust.

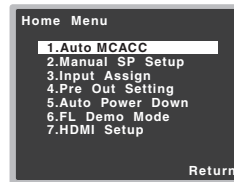

- **Auto MCACC** – This is a quick and effective automatic surround setup (see [Automatically setting up for surround sound \(MCACC\) on page 18](#)).
- **Manual SP Setup**
  - **Speaker Setting** – Specify the size and number of speakers you've connected (see below).
  - **X.Over** – Specify which frequencies will be sent to the subwoofer ([page 31](#)).
  - **Channel Level** – Adjust the overall balance of your speaker system ([page 31](#)).
  - **Speaker Distance** – Specify the distance of your speakers from the listening position ([page 32](#)).
- **Input Assign** – Specify what you've connected to the **ANALOG IN1** audio input (see [The Input Assign menu on page 32](#)).
- **Pre Out Setting** – Specify how to use the **PRE OUT SURR BACK/FRONT HEIGHT** outputs (see [The Pre Out Setting on page 33](#)).
- **Auto Power Down** – Sets to automatically turn off the power when the receiver has not operated for several hours (see [The Auto Power Down menu on page 33](#)).
- **FL Demo Mode** – Sets the demo display on the front panel display (see [The FL Demo Mode menu on page 33](#)).
- **HDMI Setup** – Set the audio return channel function (see [The HDMI Setup menu on page 33](#)).

## Manual speaker setup

This receiver allows you to make detailed settings to optimize the surround sound performance. You only need to make these settings once (unless you change the placement of your current speaker system or add new speakers).

These settings are designed to fine-tune your system, but if you're satisfied with the settings made in [Automatically setting up for surround sound \(MCACC\) on page 18](#), it isn't necessary to make all of these settings.

### Important

- Depending on the **Pre Out Setting**, there will be differences in the speaker items that can be adjusted. The OSD display for these operating instructions is an example of when the **Pre Out Setting** is set to **Surr. Back**.

## Speaker Setting

Use this setting to specify your speaker configuration (size, number of speakers). It is a good idea to make sure that the settings made in [Automatically setting up for surround sound \(MCACC\) on page 18](#) are correct.

### 1 Select 'Manual SP Setup' from the Home Menu.

### 2 Select 'Speaker Setting' from the Manual SP Setup menu.

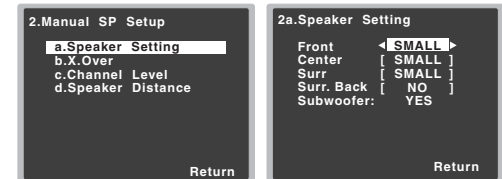

### 3 Choose the set of speakers that you want to set then select a speaker size.

Use **←/→** to select the size (and number) of each of the following speakers:

- **Front** – Select **LARGE** if your front speakers reproduce bass frequencies effectively, or if you didn't connect a subwoofer. Select **SMALL** to send the bass frequencies to the subwoofer.

- **Center** – Select **LARGE** if your center speaker reproduces bass frequencies effectively, or select **SMALL** to send bass frequencies to the other speakers or subwoofer. If you didn't connect a center speaker, choose **NO** (the center channel is sent to the other speakers).
- **Front Height** – Select **LARGE** if your front height speakers reproduce bass frequencies effectively. Select **SMALL** to send bass frequencies to the other speakers or subwoofer. If you didn't connect front height speakers choose **NO**.
  - You can only adjust the **Front Height** setting when **Pre Out Setting** is set to **Height**.
- **Surr** – Select **LARGE** if your surround speakers reproduce bass frequencies effectively. Select **SMALL** to send bass frequencies to the other speakers or subwoofer. If you didn't connect surround speakers choose **NO** (the sound of the surround channels is sent to the other speakers).
- **Surr. Back** – Select the number of surround back speakers you have (one, two or none). Select **LARGE** if your surround back speakers reproduce bass frequencies effectively. Select **SMALL** to send bass frequencies to the other speakers or subwoofer. If you didn't connect surround back speakers choose **NO**.
  - You can only adjust the **Surr. Back** setting when **Pre Out Setting** is set to **Surr. Back**.
  - If you select one surround back speaker only, make sure that additional amplifier is hooked up to the **PRE OUT L (Single)** terminal.
- **Subwoofer** – LFE signals and bass frequencies of channels set to **SMALL** are output from the subwoofer when **YES** is selected (see notes below). Choose the **PLUS** setting if you want the subwoofer to output bass sound continuously or you want deeper bass (the bass frequencies that would normally come out the front and center speakers are also routed to the subwoofer). If you did not connect a subwoofer choose **NO** (the bass frequencies are output from other speakers).

#### 4 When you're finished, press RETURN.

You return to the Manual SP Setup menu.

#### Note

- If you select **SMALL** for the front speakers, the subwoofer will automatically be fixed to **YES**. Also, the center, surround, surround back and front height speakers can't be set to **LARGE** if the front speakers are set to **SMALL**. In this case, all bass frequencies are sent to the subwoofer.
- If the surround speakers are set to **NO**, the surround back speakers will automatically be set to **NO**.
- If you have a subwoofer and like lots of bass, it may seem logical to select **LARGE** for your front speakers and **PLUS** for the subwoofer. This may not, however, yield the best bass results. Depending on the speaker placement of your room you may actually experience a decrease in the amount of bass due to low frequency cancellations. In this case, try changing the position or direction of speakers. If you can't get good results, listen to the bass response with it set to **PLUS** and **YES** or the front speakers set to **LARGE** and **SMALL** alternatively and let your ears judge which sounds best. If you're having problems, the easiest option is to route all the bass sounds to the subwoofer by selecting **SMALL** for the front speakers.

#### X.Over

- Default setting: **100Hz**

This setting decides the cutoff between bass sounds playing back from the speakers selected as **LARGE**, or the subwoofer, and bass sounds playing back from those selected as **SMALL**. It also decides where the cutoff will be for bass sounds in the LFE channel.

- For more on selecting the speaker sizes, see [Speaker Setting on page 30](#).

#### 1 Select 'Manual SP Setup' from the Home Menu.

#### 2 Select 'X.Over' from the Manual SP Setup menu.



#### 3 Choose the frequency cutoff point.

Frequencies below the cutoff point will be sent to the subwoofer (or **LARGE** speakers).

#### 4 When you're finished, press RETURN.

You return to the Manual SP Setup menu.

#### Channel Level

Using the channel level settings, you can adjust the overall balance of your speaker system, an important factor when setting up a home theater system.

#### CAUTION

- The test tones used in the Channel Level settings are output at high volume.

#### 1 Select 'Manual SP Setup' from the Home Menu.

#### 2 Select 'Channel Level' from the Manual SP Setup menu.

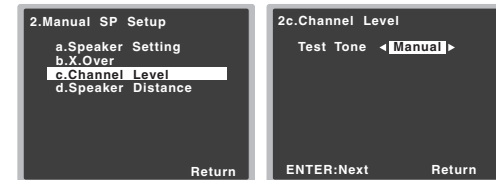

#### 3 Select a setup option.

- **Manual** – Move the test tone manually from speaker to speaker and adjust individual channel levels.
- **Auto** – Adjust channel levels as the test tone moves from speaker to speaker automatically.

#### 4 Confirm your selected setup option.

The test tones will start after you press **ENTER**. After the volume increases to the reference level, test tones will be output.

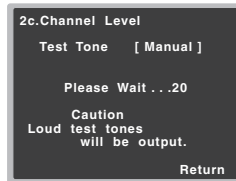

#### 5 Adjust the level of each channel using $\leftarrow/\rightarrow$ .

If you selected **Manual**, use  $\uparrow/\downarrow$  to switch speakers. The **Auto** setup will output test tones in the order shown on-screen:

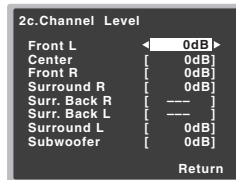

Adjust the level of each speaker as the test tone is emitted.

#### Note

- If you are using a Sound Pressure Level (SPL) meter, take the readings from your main listening position and adjust the level of each speaker to 75 dB SPL (C-weighting/slow reading).
- The subwoofer test tone is output at low volumes. You may need to adjust the level after testing with an actual soundtrack.

#### 6 When you're finished, press **RETURN**.

You return to the Manual SP Setup menu.

#### Tip

- You can change the channel levels at any time by press **RECEIVER**, then press **CH SELECT** and **LEV +/-** on the remote control. You can also press **CH SELECT** and use  $\uparrow/\downarrow$  to select the channel, and then use  $\leftarrow/\rightarrow$  to adjust the channel levels.

#### Speaker Distance

For good sound depth and separation from your system, you need to specify the distance of your speakers from the listening position. The receiver can then add the proper delay needed for effective surround sound.

- For the assignment of the digital signal inputs, see [Selecting the audio input signal on page 20](#).

#### 1 Select 'Manual SP Setup' from the Home Menu.

#### 2 Select 'Speaker Distance' from the Manual SP Setup menu.

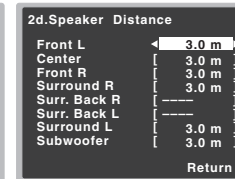
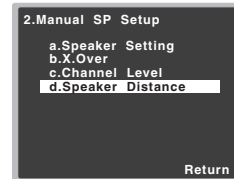

#### 3 Adjust the distance of each speaker using $\leftarrow/\rightarrow$ .

You can adjust the distance of each speaker in 0.1 m increments.

#### 4 When you're finished, press **RETURN**.

You return to the Manual SP Setup menu.

#### The Input Assign menu

**ANALOG IN1** audio input terminal is assigned to **CD** under factory settings, but this can be changed to **TV** input.

#### 1 Select 'Input Assign' from the Home Menu.



#### 2 Select 'Analog Input' from the Input Assign menu.

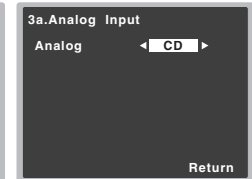
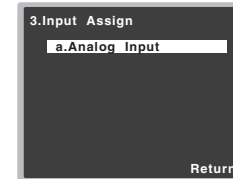

#### 3 Select the desired input option for the ANALOG IN1 audio input terminal.

#### 4 When you're finished, press **RETURN**.

You return to the Input Assign menu.



## The Pre Out Setting

Specify either using the surround back speaker or the front height speaker connection with the **PRE OUT SURR BACK/FRONT HEIGHT** outputs. An additional amplifier is required for the speaker connection.

- Default setting: **Surr. Back**

### 1 Select 'Pre Out Setting' from the Home Menu.

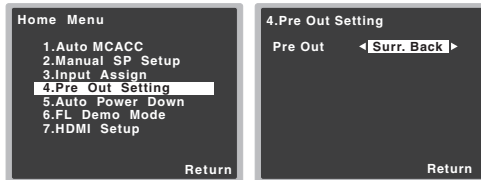

### 2 Select which speaker to connect to the PRE OUT SURR BACK/FRONT HEIGHT outputs using ←/→.

- **Surr. Back** – Connect the surround back speaker.
- **Height** – Connect the front height speaker.

### 3 When you're finished, press RETURN.

You return to the Home Menu.

## The Auto Power Down menu

Set to automatically turn off the receiver after a specified time has passed (when the power has been on with no operation for several hours).

- Default setting: **OFF**

### 1 Select 'Auto Power Down' from the Home Menu.

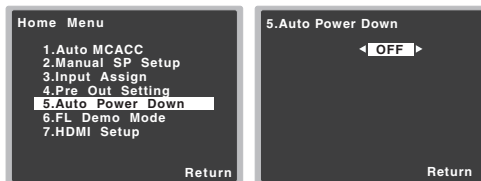

### 2 Specify the amount of time to allow before the power is turned off (when there has been no operation).

- You can select 2, 4 or 6 hours, or **OFF** (if no automatic shutoff is desired).

### 3 When you're finished, press RETURN.

You return to the Home Menu.

## The FL Demo Mode menu

Set whether or not various demos are to be shown on the front panel display.

### 1 Select 'FL Demo Mode' from the Home Menu.

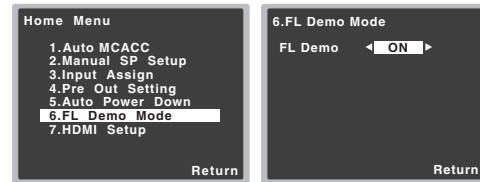

### 2 Choose ON or OFF for the demo display.

### 3 When you're finished, press RETURN.

You return to the Home Menu.

## The HDMI Setup menu

If your TV supports an audio return channel (ARC) function, connect your TV and this unit with an HDMI cable and the TV audio will be inputted into this unit via the HDMI terminal without the need for an audio cable to be connected.

### Important

- Use a High Speed HDMI® Cable when using the ARC function. The ARC function may not operate properly with other HDMI cables.

### 1 Select 'HDMI Setup' from the Home Menu.

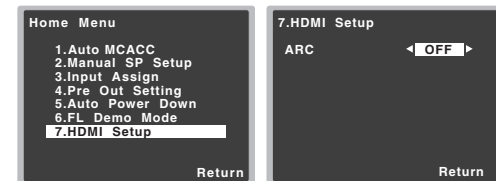

### 2 Choose the 'ARC' setting you want.

When a TV supporting the HDMI Audio Return Channel function is connected to the receiver, the sound of the TV can be input via the HDMI terminal.

- **ON** – The TV's sound is input via the HDMI terminal.
- **OFF** – The TV's sound is input from the audio input terminals other than HDMI inputs.

### 3 When you're finished, press RETURN.

You return to the Home Menu.

### Before starting ARC operation

When starting ARC operation, put the TV and this unit in STANDBY mode after connecting this unit with the TV. Next, turn ON the power of this unit and then the TV, in this order. In order to start ARC operation, after connecting this unit to a TV with an HDMI cable, you will need to switch the input on the TV to the input mode required to connect to this unit. Then, you can select a TV program.

### Important

- The ARC function may not operate even if the above conditions are met. If this is the case, listen to the TV audio after connecting this unit and the TV with an audio cable.
- The CEC (Consumer Electronic Control) function may activate when the ARC function is turned ON, causing power to turn ON and OFF and the input to switch from one to another. Since this unit does not guarantee synchronized operation based on the CEC function, we recommend that you turn OFF the HDMI CONTROL setting on the connected player. This unit may not operate properly if the HDMI CONTROL on the player is ON. Refer to the relevant device's instruction manual for details. If this does not work, turn OFF the ARC function.  
If this is the case, listen to the TV audio after connecting this unit and the TV with an audio cable.  
In addition, this unit does not guarantee synchronized operation that allows the TV remote control to operate the volume (including mute). Use this unit to operate the volume (including mute).
- Turn OFF the power and remove the power cord from the wall socket when connecting other devices or making connection changes to this unit. After all connections are completed, insert the power cord into the wall socket.
- If the power cord is connected when the ARC function is ON, the HDMI will take 2 to 10 seconds to initialize. This unit cannot be operated during the initialization. During initialization, the HDMI indicator on the display will blink. Turn ON the unit after blinking stops.



## Troubleshooting

Incorrect operations are often mistaken for trouble and malfunctions. If you think that there is something wrong with this component, check the points below. Take a look at the other components and electrical appliances being used, because sometimes the problem may lie there. If the trouble isn't sorted out even after going through the checks below, ask your nearest Pioneer authorized independent service company to carry out repair work.

- If the unit does not operate normally due to external effects such as static electricity disconnect the power plug from the outlet and insert again to return to normal operating conditions.

## General

- ❖ **The power does not turn on.**
  - Disconnect the power plug from the outlet, and insert again.
  - Make sure there are no loose strands of speaker wire touching the rear panel. This could cause the receiver to shut off automatically.
- ❖ **The receiver suddenly switches off.**
  - When the Auto Power Down function is working, the power will automatically turn off if the receiver has not operated for several hours. Check the setting for the Auto Power Down function (see [The Auto Power Down menu on page 33](#)).
  - After about a minute (you won't be able to switch the unit on during this time), switch the receiver back on. If the message persists, call a Pioneer authorized independent service company.
- ❖ **Power automatically turns ON/OFF and the input switches from one to another. (When the ARC function is ON)**
  - The CEC (Consumer Electronic Control) function may activate when the ARC function is turned ON, causing power to turn ON and OFF and the input to switch from one to another. Since this unit does not guarantee synchronized operation based on the CEC function, turn OFF the HDMI CONTROL setting on the connected player. Refer to the relevant device's instruction manual for details. If this does not work, turn OFF the ARC function. If this is the case, listen to the TV audio after connecting this unit and the TV with an audio cable.
- ❖ **OVERHEAT shows in the display and the power turns off.**
  - The temperature within the unit has exceeded the allowable value. Try moving the unit for better ventilation ([page 2](#)).

- Lower the volume level.
- ❖ **TEMP shows in the display and the volume level drops.**
  - The temperature within the unit has exceeded the allowable value. Try moving the unit for better ventilation ([page 2](#)).
- Lower the volume level.
- ❖ **No sound is output when an input function is selected.**
  - Use **VOLUME +/-** to turn up the volume.
  - Press **MUTE** on the remote control to turn muting off.
  - Set the **SIGNAL SEL** to **H** (HDMI), **C1/O1** (digital) or **A** (analog) according to the type of connections made ([page 20](#)).
  - Make sure the component is connected correctly (see [Connecting your equipment on page 10](#)).
  - Check the audio output settings of the source component.
  - Refer to the instruction manual supplied with the source component.
- ❖ **No image is output when an input function is selected.**
  - Make sure the component is connected correctly (see [Connecting your equipment on page 10](#)).
  - Use the same type of video cables for the source component and TV to connect to this receiver (see [About video outputs connection on page 13](#)).
  - The video input selected on the TV monitor is incorrect. Refer to the instruction manual supplied with the TV.
- ❖ **No sound from subwoofer.**
  - Make sure the subwoofer is switched on.
  - If the subwoofer has a volume knob, make sure it's turned up.
  - The Dolby Digital or DTS source you are listening to may not have an LFE channel.
  - Switch the subwoofer setting in [Speaker Setting on page 30](#) to **YES** or **PLUS**.
  - Switch the **LFE ATT (LFE Attenuate)** on [page 28](#) to **LFEATT 0** or **LFEATT 5**.
- ❖ **No sound from surround or center speakers.**
  - Connect the speakers properly ([page 11](#)).
  - Refer to [Speaker Setting on page 30](#) to check the speaker settings.
  - Refer to [Channel Level on page 31](#) to check the speaker levels.
- ❖ **The Phase Control feature doesn't seem to have an audible effect.**
  - If applicable, check that the lowpass filter switch on your subwoofer is off, or the lowpass cutoff is set to the highest frequency setting. If there is a PHASE setting on your subwoofer, set it to 0° (or depending on the subwoofer, the setting where you think it has the best overall effect on the sound).
- Make sure the speaker distance setting is correct for all speakers (see [Speaker Distance on page 32](#)).
- ❖ **Considerable noise in radio broadcasts.**
  - Connect the antenna ([page 16](#)) and adjust the position for best reception.
  - Route any loose cables away from the antenna terminals and wires.
  - Fully extend the FM wire antenna, position for best reception, and secure to a wall (or connect an outdoor FM antenna).
  - Connect an additional internal or external AM antenna ([page 16](#)).
  - Turn off equipment causing interference or move it away from the receiver (or move antennas farther away from equipment causing noise).
- ❖ **Broadcast stations cannot be selected automatically.**
  - Connect an outdoor antenna ([page 16](#)).
- ❖ **Noise during playback of a cassette deck.**
  - Move the cassette deck away from your receiver, until the noise disappears.
- ❖ **No sound is output or a noise is output when software with DTS is played back.**
  - Make sure the player's settings are correct and/or the DTS signal out is on. Refer to the instruction manual supplied with the DVD player.
- ❖ **There seems to be a time lag between the speakers and the output of the subwoofer.**
  - See [Automatically setting up for surround sound \(MCACC\) on page 18](#) to set up your system again using MCACC (this will automatically compensate for a delay in the subwoofer output).
- ❖ **After using the Auto MCACC setup, the speaker size setting (LARGE or SMALL) is incorrect.**
  - Low-frequency noise could have been caused by an air conditioner or motor. Switch off all appliances in the room and rerun the Auto MCACC setup.
- ❖ **Can't operate the remote control.**
  - Replace the batteries ([page 9](#)).
  - Operate within 7 m, 30° of the remote sensor ([page 9](#)).
  - Remove the obstacle or operate from another position.
  - Avoid exposing the remote sensor on the front panel to direct light.
- ❖ **The display is dark or off.**
  - Press **DIMMER** on the remote control repeatedly to return to the default.



❖ **The front panel display switches over for no apparent reason to various different displays.**

→ This happens because the demo display is in operation. To turn off the demo display, press any button to go back to the original display, or set the **FL Demo Mode** to **OFF** (see [The FL Demo Mode menu on page 33](#)).

❖ **The receiver doesn't recognize iPod touch/iPhone.**

→ Try the following.

1. Simultaneously keep pressing the sleep button and home button on the iPod touch or iPhone for over 10 seconds to restart.
2. Turn on the receiver.
3. Connect the iPod touch/iPhone to the receiver.

## HDMI

❖ **No picture or sound.**

→ If the problem still persists when connecting your HDMI component directly to your monitor, please consult the component or monitor manual or contact the manufacturer for support.

❖ **No picture.**

→ Video signals that are input from the analog video terminal will not output from the HDMI terminal. Signals that are input from the HDMI terminal will not output from the analog video terminal. Be consistent with the type of cable between input and output.

→ Depending in the output settings of the source component, it may be outputting a video format that can't be displayed. Change the output settings of the source, or connect using the composite video jacks.

→ This receiver is HDCP-compatible. Check that the components you are connecting are also HDCP-compatible. If they are not, please connect them using the composite video jacks.

→ Depending on the connected source component, it's possible that it will not work with this receiver (even if it is HDCP-compatible). In this case, connect using the composite video jacks between source and receiver.

→ If video images do not appear on your TV, try adjusting the resolution, Deep Color or other setting for your component.

→ To output signals in Deep Color, use an HDMI cable (High Speed HDMI® Cable) to connect this receiver to a component or TV with the Deep Color feature.

❖ **The OSD screen (Home Menu, etc.) isn't displayed.**

→ The OSD will not appear if you have connected using the HDMI output to your TV. Use composite connections when setting up the system.

❖ **No sound, or sound suddenly ceases.**

→ Check that the **HDMI** setting is set to **AMP** ([page 28](#)).

→ If the component is a DVI device, use a separate connection for the audio.

→ HDMI format digital audio transmissions require a longer time to be recognized. Due to this, interruption in the audio may occur when switching between audio formats or beginning playback.

→ Turning on/off the device connected to this unit's HDMI OUT terminal during playback, or disconnecting/connecting the HDMI cable during playback, may cause noise or interrupted audio.

## Important information regarding the HDMI connection

There are cases where you may not be able to route HDMI signals through this receiver (this depends on the HDMI equipped component you are connecting-check with the manufacturer for HDMI compatibility information).

If you aren't receiving HDMI signals properly through this receiver (from your component), please try the following configuration when connecting up.

### Configuration

Connect your HDMI-equipped component directly to the display using an HDMI cable. Then use the most convenient connection (digital is recommended) for sending audio to the receiver. See the operating instructions for more on audio connections. Set the display volume to minimum when using this configuration.

### Note

- Depending on the component, audio output may be limited to the number of channels available from the connected display unit (for example audio output is reduced to 2 channels for a monitor with stereo audio limitations).
- If you want to switch the input source, you'll have to switch functions on both the receiver and your display unit.
- Since the sound is muted on the display when using the HDMI connection, you must adjust the volume on the display every time you switch input sources.

## iPod messages

❖ **'iPod/USB Error 1 (I/U ERR1)', 'iPod/USB Error 3 (I/U ERR3)'**

→ Switch off the receiver and reconnect the iPod to the receiver. If this doesn't seem to work, try resetting your iPod.

❖ **'iPod/USB Error 2 (I/U ERR2)'**

→ Switch off the receiver and reconnect the iPod to the receiver. If this doesn't seem to work, try resetting your iPod.

→ An iPod not supported by this receiver is connected. Connect the iPod supported by this receiver ([page 22](#)).

❖ **'No Track'**

→ When there are no tracks in the category selected on the iPod. Select a different category.

## USB messages

❖ **'iPod/USB Error 1 (I/U ERR1)'**

→ There is a problem with the signal path from the USB to the receiver. Switch off the receiver and reconnect the USB to the receiver.

❖ **'iPod/USB Error 3 (I/U ERR3)'**

→ When there is no response from the USB. Switch off the receiver and reconnect the USB to the receiver.

❖ **'iPod/USB Error 4 (I/U ERR4)'**

→ The power requirements of the USB device are too high for this receiver. Switch off the receiver and reconnect the USB to the receiver.



## About iPod/iPhone

Made for



iPod



iPhone

“Made for iPod” and “Made for iPhone” mean that an electronic accessory has been designed to connect specifically to iPod or iPhone, respectively, and has been certified by the developer to meet Apple performance standards. Apple is not responsible for the operation of this device or its compliance with safety and regulatory standards. Please note that the use of this accessory with iPod or iPhone may affect wireless performance.

*Apple, iPhone, iPod, iPod shuffle, iPod nano, iPod classic, iPod touch and iTunes are trademarks of Apple Inc., registered in the U.S. and other countries.*

## Resetting the main unit

Use this procedure to reset all the receiver's settings to the factory default. Use the front panel controls to do this.

- 1** Switch the receiver into standby.
- 2** While holding down **BAND**, press and hold **⓪STANDBY/ON** for about two seconds.
- 3** When you see **RESET?** appear in the display, press **AUTO SURROUND/STREAM DIRECT**. **OK?** shows in the display.
- 4** Press **ALC/STANDARD SURR** to confirm. **OK** appears in the display to indicate that the receiver has been reset to the factory default settings.

### Important

- If the ARC function is ON, you may not be able to initialize the unit. If this happens, turn OFF the ARC function or turn OFF all the connected device before turning OFF (STANDBY) the power for this unit, and initialize after the HDMI indicator goes out.

## Cleaning the unit

- Use a polishing cloth or dry cloth to wipe off dust and dirt.
- When the surface is dirty, wipe with a soft cloth dipped in some neutral cleanser diluted five or six times with water, and wrung out well, and then wipe again with a dry cloth. Do not use furniture wax or cleansers.
- Never use thinners, benzene, insecticide sprays or other chemicals on or near this unit, since these will corrode the surface.



*Manufactured under license from Dolby Laboratories. “Dolby”, “Pro Logic”, “Surround EX”, and the double-D symbol are trademarks of Dolby Laboratories.*



*Manufactured under license under U.S. Patent Nos: 5,956,674; 5,974,380; 6,226,616; 6,487,535; 7,212,872; 7,333,929; 7,392,195; 7,272,567 & other U.S. and worldwide patents issued & pending. DTS-HD, the Symbol, & DTS-HD and the Symbol together are registered trademarks & DTS-HD Master Audio is a trademark of DTS, Inc. Product includes software. © DTS, Inc. All Rights Reserved.*

## Specifications

### Audio Section

FTC power output	65 W + 65 W (STEREO, 20 Hz to 20 kHz, 8 $\Omega$ , 0.2 %)
Rated power output (Front, Center, Surround)	125 W per channel (1 kHz, 6 $\Omega$ , 1 %)
Maximum power output (Front, Center, Surround)	150 W per channel (1 kHz, 6 $\Omega$ , 10 %)
Total Harmonic Distortion	0.06 % (20 Hz to 20 kHz, 8 $\Omega$ , 50 W/ch)
Guaranteed speaker impedance	6 $\Omega$ to 16 $\Omega$
Input (Sensitivity/Impedance)	
LINE	.200 mV/47 k $\Omega$
Signal-to-Noise Ratio (IHF, short circuited, A network)	
LINE	.98 dB

### Video Section

Signal level	
Composite	1 Vp-p (75 $\Omega$ )

### Tuner Section

Frequency Range (FM)	87.5 MHz to 108 MHz
Antenna Input (FM)	75 $\Omega$ unbalanced
Frequency Range (AM)	
9 kHz step	531 kHz to 1602 kHz
10 kHz step	530 kHz to 1700 kHz
Antenna (AM)	Loop antenna

### Digital In/Out Section

HDMI terminal	Type A (19-pin)
HDMI output type	5 V, 100 mA
USB (iPod) terminal	USB2.0 Full Speed (Type A) 5 V, 1 A

### Miscellaneous

Power Requirements	AC 110 V to 127 V/220 V to 240 V, 50 Hz/60 Hz
Power Consumption	415 W
In standby	0.45 W (ARC OFF)
Dimensions	435 mm (W) x 168 mm (H) x 342.5 mm (D)
Weight (without package)	8.7 kg

### Furnished Parts

Microphone (for Auto MCACC setup)	1
Remote control	1
Dry cell batteries (AAA size IEC R03)	2
AM loop antenna	1
FM wire antenna	1
Power cord	
Quick start guide	
Safety Brochure	
These operating instructions (CD-ROM)	

### Note

- The specifications are applicable when the power supply is 230 V.
- Specifications and the design are subject to possible modifications without notice, due to improvements.



© 2012 PIONEER CORPORATION.  
All rights reserved.

---

**PIONEER CORPORATION**

1-1, Shin-ogura, Saiwai-ku, Kawasaki-shi, Kanagawa 212-0031, Japan

**PIONEER ELECTRONICS (USA) INC.**

P.O. BOX 1540, Long Beach, California 90801-1540, U.S.A. TEL: (800) 421-1404

**PIONEER ELECTRONICS OF CANADA, INC.**

340 Ferrier Street, Unit 2, Markham, Ontario L3R 2Z5, Canada TEL: 1-877-283-5901, 905-479-4411

**PIONEER EUROPE NV**

Haven 1087, Keetberglaan 1, B-9120 Melsele, Belgium TEL: 03/570.05.11

**PIONEER ELECTRONICS ASIACENTRE PTE. LTD.**

253 Alexandra Road, #04-01, Singapore 159936 TEL: 65-6472-7555

**PIONEER ELECTRONICS AUSTRALIA PTY. LTD.**

5 Arco Lane, Heatherton, Victoria, 3202, Australia, TEL: (03) 9586-6300

**PIONEER ELECTRONICS DE MEXICO S.A. DE C.V.**

Blvd.Manuel Avila Camacho 138 10 piso Col.Lomas de Chapultepec, Mexico, D.F. 11000 TEL: 55-9178-4270

K002\_B3\_En

<ARB7468-A>